

Stipulation for use:

The digital System Phone ST 40 S0 is for the connection to an internal S0-Bus of an AGFEO ISDN Telephone System. The ST 40 may be connected to the following AGFEO ISDN Telephone Systems:

- AS 151 plus, AS 181 plus, AS 181 plus EIB from Software 8.1
- AS281 All-In-One, AS 35, AS 35 All-In-One from Software 7.0
- AS 40 P (P400-1), AS 4000 (P400-1), AS 100 IT (P400 IT), AS 43, AS 45, AS 200 IT from Software 7.0

The digital System Phone ST 40 UP0 is for the connection to an UP0-Bus of an AGFEO ISDN Telephone System. The ST 40 UP0 may be connected to the following AGFEO ISDN Telephone Systems:

- AS 43, AS 45, AS 200 IT from Software 7.5

Please note due to the higher power consumption of the AGFEO ST 40 when connected to the internal S0-Bus and the limited system capacity for systems already on the market like the AS 40P (P400-1), AS 4000 (P400-1) and AS 100 IT (P400 IT), it may become necessary to use additional power supply units. A ST 40 has a maximum power consumption of 1,7 Watt (all LEDS are lit, A Module 40 inserted, with ringer active, volume to maximum) the S0 Bus of an S0 440 module is based on a double port (4,5 Watt), therefore the max. load is already over the permitted limit with the connection of 2 x ST 40 and 1 x ST 30 (P max. 1,3 Watt) in the worst case scenario. In such cases the system may activate the safety protection circuit for the relevant double port. (System Phones / ISDN Bus without any function. After reset of the system the ports will be reinstated)! In such eventualities an additional power supply should be connected in order to avoid such failure to occur.

The power supplies are available from your distributor, AGFEO Ref. No. 1542431. (Identical to Power Supply Unit STE 30 / DECT S0 Base)!

Information regarding software upgrades are available via your dealer.

AGFEO will not accept any liability for damages which may result from improper use of the digital System Phone ST 40.

Safety Notes

- Do not connect or disconnect the subscriber's line of ST 40 during a storm.
- Lay the subscriber's line in such away that nobody steps on or tripples over it.
- Take care that no liquids spill inside the digital system telephone. This can cause short-circuits.

Regarding this User Guide.

This user manual is valid for the at the time installed system firmware. As the ST 40 is controlled via the telephone system it may be that after a firmware change some parts of this manual will no longer be appropriate. This manual will give a brief explanation to the operation of the ST 40 and the features of your AGFEO Telephone System. For detailed information regarding features, please refer to user manual of your Telephone System.

System Telephone ST 40

Table of Contents

Stipulation for use	2
Safety Notes	2
Regarding this User Guide.	2
Underneath the ST 40	4
The connection of an Untangler	4
Display Position	5
ST 40 Registration	5
Connect the ST 40	5
ST 40 Buttons	6
Display of the ST 40	7
Menu Guidance	7
Notes on using this Manual	7
Function Buttons - Freely programmable Function Buttons (overview)	8
LED - Display for freely programmable function buttons	10
Button Assignment	12
"Direct Access" activated	12
"Direct Access" deactivated	12
Call Waiting	13
Reject the waiting call	13
Requesting Ring back when free	13
Call Pick Up (External)	13
Call Pick Up (from Answering machine)	13
Display Call Log	14
Programming the Do Not Disturb function	14
Changing the retrieval method	14
Phonebook (Numeric retrieval)	14
Phonebook (Alphabetic retrieval)	15
Phonebook (Vanity retrieval)	15
Extended Redial	15
Automatic Redial	15
Place of Installation	16
Cleaning	16
Inserting inscription for the function keys	16
DHSG Headset (Cordless Headset)	17
Connection of Headset	17
DSHG Headset Operation	18
ST 40 Firmware Upgrade	18

System Telephone ST 40

Underneath the ST 40

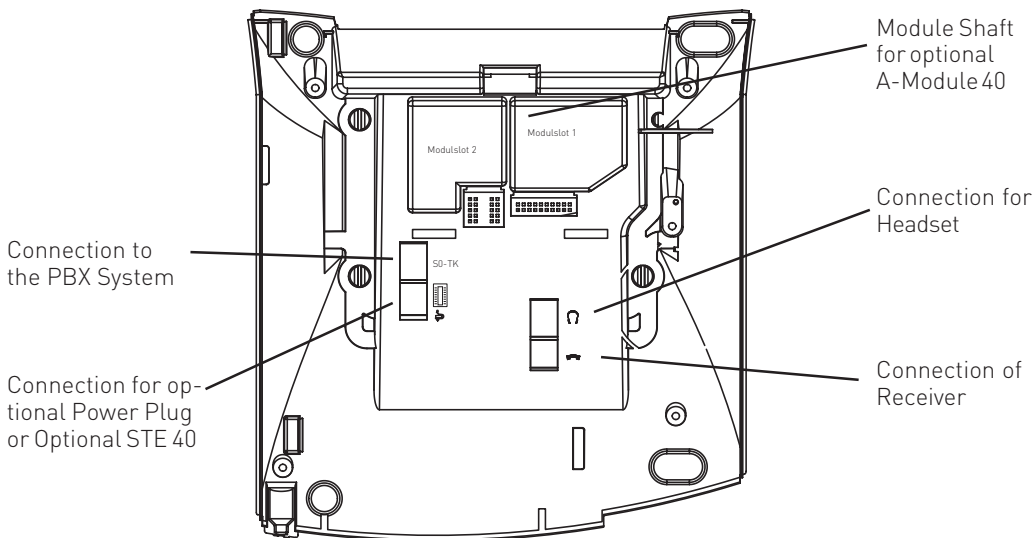

The connection of an Untangler

In the handset of the ST40 you will find a compartment for a cord unangler. Due to this design the unangler will not be obtrusive when on the phone or interfere when on the receiver is put back on hook.

- to open the handset cover , press the lid (arrow 1) and remove lid (arrow 2).
- unplug the handset cord from the handset.
- connect the unangler to the handset.
- connect the handset cable to the unangler.
- Close the lid

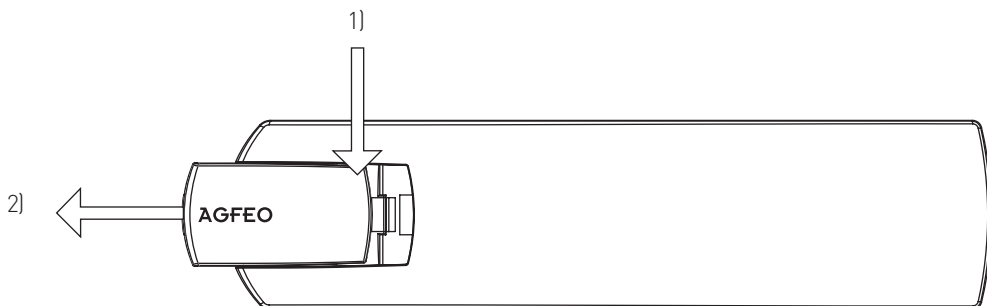

System Telephone ST 40

Display Position

Your Display can be adjusted to 6 different viewing angles.

Connect the ST 40

To operate the ST 40, please insert the RJ 45 plug into the relevant socket which is connected to the internal ISDN line of your AGFEO ISDN Telephone System.

- insert the RJ 45 plug into the socket until you hear a positive click.
- to release the plug, press the release latch on the plug and at the same time pull the cable out of the socket. (use a small screw driver if required)

To operate the ST 40 UP0, please insert the RJ 45 plug into the relevant socket which is connected to the UP0 port of your AGFEO ISDN Telephone System.

Please note only one telephone can be connected to each UP0 port.

- insert the RJ 45 plug into the socket until you hear a positive click.
- to release the plug, press the release latch on the plug and at the same time pull the cable out of the socket. (use a small screw driver if required)

Please note that the S0 Bus must be terminated with two 100 Ohm ¼ Watt Resistors, the UP0 port does not require any termination.

ST 40 Registration

An extension number will be allocated to the ST 40, like any other device when programming the telephone system. If you connect the ST 40 for the first time to the telephone system, then the digital system phone will have to be registered to the system. Please follow the instruction in the display.

System Telephone ST 40

ST 40 Buttons

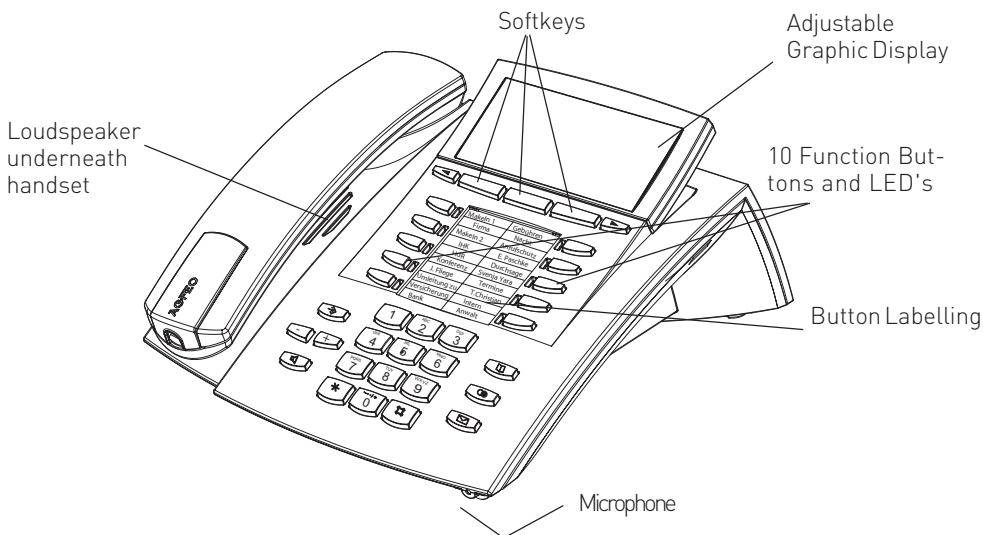

  Numeric Keypad

  * and # Buttons

 Set Button - Start and end programming. Keep this button pressed to toggle between programming tree and programming index

 Handsfree Button - Activates the Loudspeaker. Button lights up when activated.

 Arrow Buttons - To scroll through the display where there is more than one function.

 Phone Book Button - Retrieval of Telephone Numbers.

 LNR - Last Number Redial Button. Keep this button pressed to show call log.

 Mail Button - Flashes on new entry in call log or missed calls. Stays lit for numbers already viewed. Clears when number is called or deleted from list by pressing clear button

 10 function Buttons - User programmable, two entries per Button (First & Second Level) Keep this button pressed for approx 1 sec. to show the second level. LED indication only for first level.

 Plus and minus for volume control of handset and speaker.

 Softkeys: The function for these buttons are shown in the display above. Function offered are depending on the relevant phone status.

System Telephone ST 40

Display of the ST 40

Display in standby:

Internal and external S0 Status, one box per S0.

Extensions off hook. Called extension will be shown inverted.

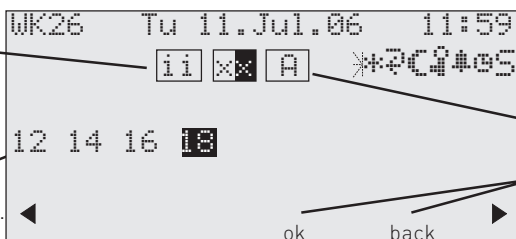



Activated features are shown here

Status of analogue trunk lines

Current function of soft key below.

1. Display Line: Date / Time

Index of functions:

- | | | | |
|---|---|----|---------------------------------------|
| ✕ | External ISDN-Line. One line (a B-channel) is busy. The "x" is shown inverted on an external call. | ☎ | Diversion/ISDN-call forwarding active |
| i | Internal ISDN-Line. One Line (a B-channel) is busy. | € | CVA 2 (Night service) on |
| A | Analogue trunk line. The "A" is shown inverted on an external call | 🔒 | Phone lock on |
| | Features: | ⏰ | Wake-up on |
| | Browse with   , Confirm with „ok“ | 📅 | Appointment on |
| ⏸ | Call-Waiting off | S | Sensor activated |
| * | Do Not Disturb on | F | Filter activated |
| | | I | Withhold own number |
| | | PC | PC Programming in process |

Menu Guidance

Please look at the display when using the telephone as it will guide you through all operating procedures. Depending on its operating condition the following soft keys are offered: Answer, Park Call, Retrieve, Get, Split, Transfer, Call Back, Conference, Recall, Reject, Disconnect, Go To, Back, End, OK, on, off, Store and Door Opener.

Notes on using this Manual

The soft keys below the phone display will be indicated by this symbol. 

The relevant button which is to be pressed will be shown in black.

Please observe the display area if no black button is indicated. Should there be more than three options, then the most used function will be shown first. More functions can be selected by pressing the arrow buttons.

System Telephone ST 40

Function Buttons - Freely programmable Function Buttons (overview)

TAM activation	To switch TAM module on or off of the ST 30 System Phone.
TAM info	To listen to messages recorded on the TAM.
TAM Memo	To record messages on the TAM
Reject	Reject the ringing call. Caller will hear busy tone.
Call Waiting Enabled / off	You can select if: If the caller will get busy tone if on a call. (off) If a waiting call should only be visually indicated on your phone. Or if a call waiting tone should be signalled. (audible)
Call Deflection	To divert an incoming call during the ringing phase. There will be no change to the ringing tone when diverted. The caller will not be aware that the call was forwarded.
Call Filter	To switch Call Filters on or off.
Call Log	Will list the Call Log
Cleaning	In connection with the check in / check out button. This can be used to signal to the front desk that a room has been cleaned and is ready for occupation.
Do not Disturb (DND)	This will disable the Tone Ringer Special function buttons may be set: DND for internal calls DND for external calls DND for internal- and external calls.
Night Service (AVA 2)	Night Service on or off. Special function buttons may be set: Night Service can be switched for each trunk line. Night Service can be switched for all trunk lines.
Call Forwarding	Enable / Disable Call Forward if designated extension does not answer on incoming call. Special function buttons may be allocated: Switch Call Forward for each trunk line. Switch Call Forward for all trunk lines.
Tannoy	Announcement via Public Address Amplifier connected to the Telephone System
Busy on Busy	Return Busy Tone to Caller if one Extension is Busy within Call Distribution Group. Special Buttons can be assigned -Busy on Busy for each Call Distribution Group switchable separately -Busy on Busy for call Call Distribution Group switchable together
Call by Call	To select Network Provider via LCR
Check In/ Check Out	Check in / Check out for Hotel applications. Will start and stop call logging and switch on or off trunk line access.
Page (Tannoy)	Pageing Announcement to System Phones. Programmable function Button - Page specific Extensions.
Units	Display Call Cost
Call Capture	Malicious Call Identification via ISDN-Exchange
Remote functions	Sending of stored DTMF Tones (1..0 * #) for a remote interrogation of a Telephone Answering Machine (TAM)
Remote Answer	Possible to make the ringing extension go off hook from another phone.
Group Button	Log in and out of Groups and their features
Headset	To use a Headset (only Digital System Phones)
Mute Button	To mute microphone on your telephone.

System Telephone ST 40

Function Buttons - Freely programmable Function Buttons (overview)

Call Pick Up	To Pick Up incoming calls. Special Function Button can be assigned to Pick Up internal and external calls from specific extensions.
Withhold	To withhold own number to be sent to a called party.
Internal Button	To Dial Extensions. Special function Button programmable: Call specific Extension
ISDN-Hold	To Hold an external call in the Telephone Exchange (only available on PTMP connection)
ISDN-Call Forwarding	To switch on or off the ISDN Call Forwarding feature.
Conference	To set up a Conference Call with Internal and or External calls.
Speaker Volume	To set the Speaker Volume Level for Handsfree or On Hook use.
LCR	To switch Least Cost Routing (LCR) on or off for your System Phone.
Call Split	To talk to more then one External Call in turn. (Switch between them)
Brokers Call	To talk to one internal and one external call at a time and without connecting them.
External	To transmit another of your MSN numbers other the the one allocated to the Extension making the call. A special Button can be assigned for this feature.
Relays	To switch a Relays. A special function Button can be assigned.
Reserve	To reserve a line should all lines be engaged at the time.
Sensor	To Enable or Disable Sensors.
SMS info	Will list all saved SMS messages
Write SMS Message	To write new SMS message.
Enquiry Call	To establish or set up an Enquiry Call, a connection or a Brokers Call
Telephone Book	To select a number out of the System Telephone Book
Telephone Lock	To Lock the System Phone and activate pr-set Emergency and Direct Call numbers.
Appointment	To set or cancel a preset Appointment Time
Timer	To switch on or off a Time based function, such as Day-Night Service, Call Forwarding, Relays etc. Button can be assigned for this function. 10 Timers are available. Timers are form 0 to 9.
Doorphone and Lock Release	Function Button can be assigned to connect to the Doorphone. Another Button can be assigned to activate Lock Release.
Transfer	To transfer and connect an external call to an external call.
Diversion from (Follow me)	To divert all calls from another phone to the current phone used.
Diversion to	To divert all calls to another extension- or external number.
Wake Up	To Enable or Disable the set Wake up call..
Destination Button	To Call a preset Telephone Number
- Public	- This number is stored in the Telephone System Memory
- Private	- This number is only stored in your telephone

System Telephone ST 40

LED - Display for freely programmable
function buttons

	LED on	LED off	LED flashes
Answering Machine Messages	Stored messages already listened to.	No Messages	New Messages
Call Waiting activation	enabled	disabled	
Call Log	Call Log entries already viewed	No numbers in Call Log	New Numbers in Call Log
Do Not Disturb	on	off	
Night Service	on	off	
Call Forwarding	set	off	
Busy on Busy	on	off	
Group Button	Logged in	Logged out	
Headset	active	off	Telephone is being called
Withhold Number	on	off	
LCR	on	off	
Relays	on	off	Relay is being rung
SMS Info	Messages already read	No Messages	New Messages
Mute Button	enabled	disabled	
Telephone Lock	on	off	
Appointment	set	off	when appointment call is ringing
Ringer Off	on	off	
Doorphone and Lock Release	connected to door phone	switched off	called from door phone
Diversion from	enabled	disabled	
Diversion to	enabled	disabled	
Wake Up	set	off	Wake up call not answered

System Telephone ST 40

LED - Display for freely programmable function buttons

	LED on	LED off	LED flashes (slowly)	LED flashes (fast)
TAM Activation	The TAM is activated	The TAM is deactivated		
Internal Button	The extension subscriber is busy. He is being called or he is calling.		The internal key is allocated to an answering machine ¹⁾ . It has taken the call. The call can be taken by pressing the key.	You are holding the internal subscriber (query or Call Split). Only you can take the call again.
Line Button	The Line is busy, it can not be used	The line is free and the subscriber can use it with an external button.	The Line is in a status for all to take the call.	The Line is being held and can be taken over only by this subscriber.
Timer Button	The Timer is on, the function is off	Both, the Timer and the function are off.	Both, the Timer and the function are on.	
Destination Button		Goes off as soon as somebody answers the call.	Flashes when the number calls. The call can be picked up by pressing a key.	

General information on the Line-key

The line-keys are supported by an ST 30 because an allocated LED is indispensable. Another condition for meaningful use is that, two keys are always installed for one line. In the „resting“ status, you can get further information about the line by pressing a flashing line-key (e.g. the caller's phone number). Press the flashing line-key in the 'pick up' status, take the call.

1) Only valid for answering machine at analogous Port

System Telephone ST 40

Button Assignment

On delivery of the Phone System all programmable function Buttons of the Phones have a default setting which are the same on all System Telephones.

These Buttons can be individual programmed to suit your specific needs.

Announce	Call Waiting
System Memory	System Memory
Appointment	Tone Call
System Memory	System Memory
Call Filter	Mute
System Memory	System Memory
System Memory	Diversion to
System Memory	System Memory
System Memory	Internal
System Memory	System Memory

Changing Button Assignment



Start
Programming



Enter PIN if
prompted



Press Button,
you want to
assign



Enter the first letter of the
function 's name, or choose
the function with arrow buttons



Confirm
selection



End
Programming

"Direct Access" activated

Calling an internal user:



Lift receiver



Press the 'Internal or Intercom' Button
and dial the required extension number.

Calling an external number:



Lift receiver



Just dial the telephone number required. The telephone system
automatically seizes an outside line.

"Direct Access" deactivated

Calling an internal user:



Lift receiver



Dial the Extension
Number only

Calling an external number:



Lift receiver



Dial 0 (or 9 if applicable) to get a line. On hearing external dial
tone dial required telephone number

System Telephone ST 40

Call Waiting

1. Possibility:



You are on a call and hear the call waiting tone

Replace the receiver to end the current call.



Your telephone will ring for you to answer the waiting call.



Lift Receiver



Conduct Call

2. Possibility:



Press „SPLIT“. The first call is placed on hold while the waiting one is connected to you. You can alter between the calls by pressing the Split Button. You can also deflect the waiting call.

Reject the waiting call

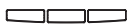

Press the „Reject“. The caller will now hear busy tone if you are the only phone programmed to ring on an incoming call. If there are also other phones programmed to ring on an incoming call then the caller continues to hear the ringing tone.



Continue your original call.

Requesting Ring back when free



On hearing the busy tone when calling an extension.



Press Softkey "RecalL". Ring back when free is initiated



Replace Receiver

Call Pick Up (External)



You wish to pick up an external call.

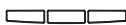

Lift receiver. Press Softkey „Get“. You are now connected to the caller.

Call Pick Up (from Answering machine)



Answering machine has accepted external callt.





Lift receiver. Press butoon Call Pick Up. Only possible if button Call Pick Up is configured to extension number of TAM.

System Telephone ST 40

Display Call Log

The flashing mail button will indicate that there is one entry in the call log. With the receiver on hook press the mail button. The last missed call will be displayed giving telephone number, date and time. The LED will continue to be lit until you return the call or delete the entry from the call log.

You can use the arrow keys to view further entries.  

The displayed number will be dialled as soon as you lift the receiver. The entry will be automatically being deleted if the caller answers. The entry will remain in the call log if no one answers.

Delete the displayed entry by pressing the left button.

Abort the call log by pressing the right button.



Programming the Do Not Disturb function



- "1": Do not Disturb for Internal Calls
- "2": Do not Disturb for External Calls
- "3": Do not Disturb for External and Internal Calls



Press Set and button **"Do not disturb"** to start programming

Exit Programming

You can toggle „Do not Disturb“ on/off by pressing the „Do not Disturb“ button.

Changing the retrieval method



Press Phonebook button

Press "Search", choose search mode with arrow buttons and confirm with middle button

Phonebook (Numeric retrieval)



Press Phonebook button

Enter the stored location of the entry, ie 000 to 999 or use arrow buttons to scroll.



Lift the receiver or press the handsfree button. The displayed number will be dialled.

System Telephone ST 40

Phonebook (Vanity retrieval)



Press Phonebook button

Enter the desired letter, i.e. A=2. The first entry with the selected initial letter is displayed.



Select the next letter, i.e. N=6. The first entry with "An" is displayed.



Lift the receiver or press the handsfree button, the displayed name will automatically be dialled.

Scroll with arrow buttons  

Phonebook (Alphabetic retrieval)



Press Phonebook button

Enter the desired letter, i.e. A=2. The first entry with the selected initial letter is displayed.



Press the arrow button to move to the input for the second letter.



Enter the second letter, i. e. N =66.

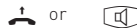

Lift the receiver or press the handsfree button. The displayed phone number will be dialled automatically.

Scroll with arrow buttons  

Extended Redial



With the receiver on hook. Press the "redial" button. The last phone number dialled is displayed.



Select one of the 10 last phone numbers displayed by using the arrow buttons.



Lift the receiver. The displayed phone number is dialled.

Automatic Redial



With the receiver on hook. Press the "redial" button. The last phone number dialled is displayed.



With the receiver on hook press the redial button. The last number dialled is displayed. Automatic redial will start once you press the emiddle button. The LCD will display how many more times the system is trying to the requird number. The speaker will be switched on automatically once the connection has been established.

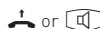

Pick up the receiver or press the speaker button as otherwise the line will be cleared down after 10 seconds.

System Telephone ST 40

Place of Installation

Install ST 40 in an appropriate place. Please pay attention to the following during the installation:

- Not in places, where the phone can be sprayed with water or chemicals.
- Synthetic support at the base of the phone:
Your apparatus was manufactured for normal conditions of use. Chemicals used in the production or care of furniture can cause changes to the synthetic support of the phone. Such apparatus supports changed by extraneous influence can leave behind unpleasant marks. Due to understandable reasons, liability for such damages can not be taken. Use therefore a non-slippery base for your phone, especially on new or freshly vanished furniture.

Cleaning

You can easily clean your phone. Pay attention to the following:

- Wipe the phone with slightly moist or antistatic cloth.
- Never use dry cloth (charging could lead to defective electronics).
- Take care by all means that moisture does not ooze into the phone (switch and contacts could be damaged).

Inserting inscription for the function keys

Your ST 40 includes a printed designation strip which shows the button allocation in default. You may use the reverse to enter your own designation.

Use a finger-nail between the upper end of the window and the phone casing. Pull the window downwards until it buckles. You can now take it out.

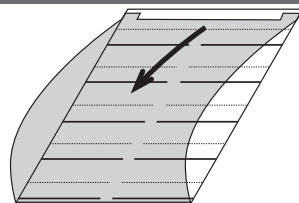

Insert the inscription strips. You can print corresponding labels on your PC, using the TK-Set configuration programm.

Re-insert the window at the lower end in the recess for inlay. By pressing downwards, the window buckles and you can replace it.

System Telephone ST 40

DHSG Headset (Cordless Headset)

The DHSG connectivity is a new industry standard which is supported by various headset - and other apparatus manufacturers. This bi-directional connection makes it possible to deliver a high functionality between telephone and headset from different manufacturers. The telephone can signal to the headset via the DHSG connection if it is on - or off hook and if the telephone is ringing. Likewise the headset is able to signal to the phone if it wants to be on - or off hook. The condition will be that both devices, telephone and headset, are able to support this type of protocol.

Connection of Headset

The ST 40 has a separate RJ 10 headset connection. Instead of connecting the cordless DHSG Headset AGFEO 9120 you may also use some of the following corded headsets:

Manufacturer	Model	Order No.
AGFEO	Headset 2100	6548839
	Headset 2200	6548847
Plantronics	Supra Monaural Polaris Modell P51 *	32190-04
	Tristar Modell P81 *	33695-01
	* including connection cable U10P	38058-01
GN Netcom	Profile monaural **	1861-15-03
	Optima NC monaural **	1913-29-01
	** Including connection cable	8800-00-01

The headset socket can be found underneath the ST 40 (See Page 4). The socket is marked with a headset symbol.

- insert the headset plug into the headset socket until you hear a positive click.
- lay the cable in the cable duct underneath the ST 40 which is also used as a strain relief
- to unplug the cable, release the latch on the plug (use a small screw driver if required) and at the same time pull the plug out of the socket.

Please note you may need an adapter from RJ45 to RJ 11.

System Telephone ST 40

DSHG Headset Operation

Please program a headset button for the ST 40 or STE 40 either via TK Suite Basic or the system programming code XX31.

- You now will be able to answer or clear a call for the headset.
Your headset will also ring in the earpiece once your telephone rings.
- You can answer the call by pressing the programmed headset button on the ST 40 or STE 40, or by pressing the button directly on your headset.
- If so required you may disable the ringer of the ST 40 but still will hear a call ringing directly in the earpiece of your headset. This will be ideal for call centres or open plan offices.
- If the caller hangs up, then the telephone system will also clear the call and the headset goes automatically on hook. There is no need to press a button on the ST 40 or the headset to go back on hook.

ST40 Firmware Upgrade

Your System Phone ST 40 can be upgraded to the latest firmware level without the need to change any hardware. To do so please do the following:



With the handset on hook the System Phone ST 40 is idle.

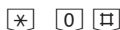

Press the buttons  all at the same time. The ST 40 is now in service mode.



Select Software Update by pressing the digit . If for any reason you do not want to continue with the update but want the phone to return to normal operation, then press digit 3 "Hauptprogramm" (Main Program).



Enter the telephone number of the Update Server
004952144709950
[Updateserver AGFEO Bielefeld]
If required enter access digit 9 if no spontaneous line seizure is set.:
9004952144709950



Confirm entry with middle soft button (ok). The Update Server will now be dialled and the update will start.

The update will be completed within approx. 90 seconds. The ST 40 will automatically re register to the telephone system. On start up the software level will be displayed on the phone. The update is now completed.

EU-Konformitätserklärung

EC-Declaration of Conformity
CE-Déclaration de Conformité

Der Hersteller: AGFEO GmbH & Co. KG

The Manufacturer:
Le Constructeur:

Adresse: Gaswerkstr. 8
D - 33647 Bielefeld

Address:
Adresse:

Erklärt, dass das Produkt: ST 40

Declares that the Product:
Déclare que le Produit:

Type: Systemtelefon

Model: ST 40

Components:

die grundlegenden Anforderungen gemäß Artikel 3 der nachstehenden EU-Richtlinien erfüllt:

meets the essential requirements according to article 3 of the following EC-Directive:
est conforme aux exigences essentielles d' article 3 de la Directive CE:

**Richtlinie 1999/5/EG des Europäischen Parlaments und des Rates vom 09. März 1999
über Funkanlagen und Telekommunikationsendeinrichtungen und die gegenseitige
Anerkennung ihrer Konformität**

Directive 1999/5/EC of the European Parliament and of the Council of 09 March 1999 relating to radio and telecommunications terminal equipment, including the mutual recognition of their conformity
Directive 1999/5/CE du Parlement européen et du Conseil du 09 mars 1999 concernant les radio et équipement terminaux de télécommunications, incluant la reconnaissance mutuelle de leur conformité

und dass die folgenden harmonisierten Normen angewandt wurden:

and that the following harmonised standards has been applied:
et que les standards harmonisés suivants ont été appliqués:

EN 55022/2003
EN 55024/2003

Bielefeld, 5. Juli 2005

Ort und Datum der Konformitätserklärung

Place and date of the declaration Lieu et date de la déclaration

Phone : +49(0)5 21 44 70 9-0
FAX : +49(0)5 21 44 70 9-50



Name und Unterschrift
Name and Signature Nom et Signature

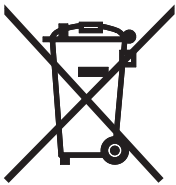

The crossed out wheeled bin on the product means that this belongs to the group of Electro- and electronic apparatus.

In this context you are directed by the European regulation to dispose of used apparatus
- at the point of buying an item of equal proportion / value
- at the local available collection point for disposal

With this you will participate in the reuse of material and valorisation of disused electric- and electronic apparatus, which otherwise could be a health hazard and be negative to the environment.



Ident no. 1101371
Subject to change without notice. No liability
can be accepted for errors contained in this
document.
Printed in Germany
0085

AGFEO GmbH & Co. KG
Gaswerkstr. 8
D-33647 Bielefeld
Internet: <http://www.agfeo.com>