

ISDN PBX-System

Manual

Business-Line: AS 35
AS 35 All-In-One



AGFEO
einfach | perfekt | kommunizieren

Safety Notes

- Installation and Maintenance of the System only by trained personnel.
- Important! To prevent personal injury and damage to equipment please ensure that the system is properly earthed and that the appropriate cable is connected in the mains plug.
- The System must be installed horizontal so that the connection panel is on the right hand side.
- Do not connect or disconnect any PSTN lines during a thunderstorm.
- Install lines and extensions in such a way that no one walks or trips over them.
- Disconnect the System from the mains supply before opening the connection panel.
Before connection of lines and extensions please ensure that the system is unplugged from the mains supply. DANGER!
- Preventive measure! Before carrying out any installation work, please touch briefly the PC/Printer socket of the telephone system. This will discharge any possible electrostatic charges, thus protecting the telephone system's electrostatically sensitive components.
- Do not allow liquids to enter the system as short-circuits may occur.
- No liability will be accepted for consequential damages such as an unintentional continued connection of a line.
- The telephone system will not operate in case of power failure and you will not be able to make any type of call.

The AS 35 is indented for the connection to Basic Rate ISDN lines (DSS1, Point to Point, System Access, or Point to Multi Point, Standard Access).

The AS 35 All-in-One can be connected to Basic Rate ISDN lines (DSS1, Point to Point, System Access, or Point to Multi Point, Standard Access) and may also be connected to analogue exchange lines.

Should you operate the AS 35 All-In-One on an analogue exchange line, then please ensure that your telephone service provider has meter pulse sending disabled as this may otherwise interfere with speech quality of a call.

You may connect any equipment which has been approved for the connection to the Public Switched Telephone Network (PSTN) to the extension port of the system.

Any DSS1 ISDN device which has been approved for the connection to the ISDN telephone exchange may be connected to the internal SO Bus. In addition you may connect up to two digital AGFEO System Phones to each SO Bus.

Any other use of the telephone system which is not listed or described is prohibited.

The telephone system has been issued with a universal connection licence.

The system fulfils the specified conformity and safety regulations.

About This Manual

The instruction is valid for the default setting of the system. If the system should be modified due to software made available through the manufacturer then it may be possible that sections of the instruction manual become invalid. All listed ISDN features will be supported by the system. However, some features may not be available through the Network Operator.

Introduction

Tables of Content

Introduction

Safety Notes	E - 2
About This Manual	E - 2
The AS 35 Telephone System	E - 6
The AS 35 All-In-One Telephone System	E - 7
Important notes on using analogue equipment	E - 8
CTI - computer telephony integration	E - 10
System telephones	E - 11
Pictograms and Buttons	E - 11

Installation

Check contents of delivery	I - 3
Wall Mounting	I - 4
Open Connection Cover	I - 5
Connect Analogue Extensions	I - 9
External S0-Connection Fixed S0	I - 9
Internal S0-Connection	I - 11
Connect the AS 35 All-In-One to an analogue exchange line	I - 12
Door Phone	I - 13
Commissioning	I - 14
Technical Data AS 35	I - 16
Technical Data AS 35 All-In-One	I - 17

System Phones

System Telephone ST 25	1 - 3
System Telephone ST 30	1 - 4
System Telephones - settings	1 - 6
Setting External Seizure	1 - 11
Allocate an Extension Number	1 - 11
Overview of freely programmable Function Buttons	1 - 12
Button Assignment	1 - 14
Making a Call	1 - 19
Call Transfer	1 - 25
Requesting Ring back when free	1 - 27
Call Waiting / Callback when free	1 - 27
Call Waiting on/off	1 - 29
Call Log	1 - 31
Do Not Disturb (Setting on/ off)	1 - 33
Night Service on/ off	1 - 34
Call Forwarding (on/off)	1 - 36
Call Deflection	1 - 38
Forwarding a call during the ringing phase	1 - 38
Announcement	1 - 39
Busy on Busy	1 - 40
Announcement	1 - 41
To place a Call on Hold	1 - 44
Remote Dial Functions	1 - 45
Malicious Call Identification (MCID)	1 - 46
Tracing a Call	1 - 46

Introduction

Tables of Content

Conference	1 - 47
Least Cost Routing (LCR)	1 - 50
Call Split	1 - 51
Dialling with Call by Call Button	1 - 53
Parking / Retrieving a Call	1 - 54
Baby Listening / Room Monitor	1 - 55
Enquiry	1 - 57
Automatic Call Back	1 - 58
Pop Up Menu (Status Display)	1 - 59
Storing Phonebook Numbers (Central Dialling Memory)	1 - 61
Deleting a Number from the phonebook	1 - 63
Dialling Numbers from the Phone Book	1 - 64
Telephone Lock - Emergency/Direct Call (Baby Call)	1 - 68
Emergency Call	1 - 69
Direct Call (Baby Call)	1 - 69
Appointment Call (Non-Recurring)	1 - 70
Timer functions	1 - 72
Activating/deactivating Timers	1 - 72
Answering a Doorphone Call	1 - 75
Sending CLIP or COLP	1 - 76
Diversion from - Divert other Extensions	1 - 77
Diversion to -diverting calls to another phone	1 - 78
Check in / Check out	1 - 83
System Redial	1 - 86
Wake Up Call – Repeated Appointment Call	1 - 87
World Clock	1 - 88
Groups	1 - 91

Analogue and ISDN Phones

External Line Access	2 - 3
Call Waiting	2 - 12
Do Not Disturb	2 - 13
Switching between Day and Night Service	2 - 14
Busy on Busy	2 - 18
Announcement	2 - 19
To place a Call on Hold	2 - 20
Least Cost Routing (LCR)	2 - 24
Parking a Call	2 - 24
Switching Relays	2 - 27
Enquiry	2 - 28
Automatic Call Back	2 - 29
Telephone lock - direct call (baby call)	2 - 32
Timer Functions	2 - 34
Sending CLIP or COLP	2 - 39
Call Forwarding	2 - 43
Display Call Charges on an analogue phone	2 - 46
Telephone Answering Machine (TAM)	2 - 47
CLIP - display caller's phone number	2 - 47

Introduction

Tables of Content

Groups	2 - 48
Callthrough	2 - 49
Wake Up Call – Repeated Appointment Call	2 - 50
Integrated AIS-Module	3 - 1
Settings in TK Suite Configurator	3 - 7
Music on Hold	3 - 7
Greeting / On-Hold-Message	3 - 8
„Message before Answered by Group“	3 - 8
Extension / Group Ringing	3 - 9
Call Mode	3 - 10
Record Messages via ST 30	3 - 12
Copyright Free Music	3 - 13
Programming	
Programming from the system telephone or a/b telephone	4 - 4
Variable call times of the TFE's	4 - 8
Protecting functions of the telecommunications system against unauthorised use (code numbers)	4 - 8
Maintenance/ Testing	4 - 12
System phone registration	4 - 14
Remote setting - Remote configuration	4 - 15
Downloading new software	4 - 16
Advanced Users Programming	4 - 17
Programming tree	4 - 18
CommuniCation via a PC	
Software Overview	PC - 3
Connection to the Internet or another network	PC - 9
Appendix	
Glossary	A - 2
Appendix	A - 12
Tones	A - 13
Index	
Index	S - 2
Declaration of Conformity	S - 6
Declaration of Conformity	S - 7

Introduction

The AS 35 Telephone System

The AGFEO AS 35 is configured for up to 18 extensions and offers in addition an integrated AIS Module. The AIS (Audio Information System) offers automatic announcements of advertising, music on hold, door phones - or security messages and wake up calls.

Basic configuration of the AS 35:

- 1 SO Bus External (ISDN Line)
- 3 SO Bus External (ISDN Line) or internal (Digital Phones)
- 12 POT Ports for analogue equipment of which 1 can be used for a door phone
- 1 PC Connection (RS232)
- 1 USB Port for PC programming
- 1 AIS Module (Audio Information System)
- Software Package TK Suite Basic

Optional

- AGFEO DECT SO Base via an internal SO Bus
- Wireless Alarm Controller via RS 232

Note

Some products may only be available in certain countries.
Please ask your dealer for further information.

Introduction

The AS 35 All-In-One Telephone System

The AS 35 All-In-One is so much more than “just” a telephone system for the connection to the analogue telephone exchange. With the option to select the operation of an internal or external SO Bus the system may also be operated with a mixture of lines, analogue – or ISDN lines.

The connection to Internet Telephony Providers to use services such as Voice over IP is also possible without any problems. The AS 35 All-In-One will also support Voice over IP services via an Analogue Telephone Adaptor (ATA) which allows access to the SIP Gateway of the IP Provider. The port of the analogue exchange line will be connected to the output of the ATA and therefore all extensions connected to the telephone system can make calls via the IP network of the various providers.

The connection of the telephone adaptor (ATA) to the exchange line side of the telephone system will offer the use of features like exchange line access, CTI, Call Diversion, Least Cost Routing, CLIP etc. The familiar operation for the extension user remains unchanged.

Basic configuration of the AS 35 All-In-One:

- 2 Analogue Exchange Lines
- 2 SO Bus External (ISDN Line) or internal (Digital Phones)
- 12 POT Ports for analogue equipment of which 1 can be used for a door phone
- 1 PC Connection (RS232)
- 1 USB Port for PC programming
- 1 AIS Module (Audio Information System)
- Software Package TK Suite Basic

Optional:

- AGFEO DECT SO Base via an internal SO Bus
- Wireless Alarm Controller via RS 232

Note

Some products may only be available in certain countries.
Please ask your dealer for further information.

Introduction

Important notes on using analogue equipment

Only analogue Apparatus which are approved to be connected to the Public Switched Telephone Network (PSTN) may be connected to the analogue side of the system. This includes all 2 wire telephones, answering -, fax machines, and modems.

The system supports both dialling method Loop Disconnect (LD) or Dual Tone Multi Frequency (DTMF). DTMF is a faster dialling method. The system will detect the dialling method automatically.

From an analogue phone, you can call any extension free of charge by dialling the internal phone number. You can call an external number after seizing an outside line. (B channel) To do this dial **[9][0]** to get an outside line and then dial the telephone number required.

If you set "spontaneous exchange line seizure with internal " for your telephone extension then you must press the hash button before the internal phone number. Note in this mode you cannot call an extension if your phone is an older LD or rotary type dial phone.

To carry out system functions, your phone must have a STAR Button (**[*]**). The sequence to enter will be **[*]** followed by the function number. If your phone is an older type LD phone then you can dial **[9][9]** instead of **[*]**.

To make an enquiry call you phone must have an **[R]** Button (Recall Button). The signalling for this must be set to Timed Break Recall (TBR). On older rotary dial phones you do not need to press the **[R]** Button when making an enquiry call. System functions such as last number redial, abbreviated dialling etc, can be carried out from any LD phone. Details of such operations are given in this manual and in the short reference guide under Analogue and ISDN Terminals.

You can also use the functions of a standard analogue telephone (e.g. redial, abbreviated dialling) in conjunction with your telephone system. Please refer to the operating instructions for the telephone concerned for details of these functions.

Details of how to operate the functions of your telephone system that you are able to use from a standard analog telephone set to DTMF are given in this instruction manual and in the "short-form operating instructions for analogue and ISDN terminals".

Each programming entry will be acknowledged by a confirmation tone. If this tone is not received or if an error tone is returned then you must repeat this entry.

The telephone system is forwarding counting pulses to analogue terminals to display connection charges (charge pulses).

For data transfer via the analogue ports, the telephone system supports the V.90 standard (up to 56600 bps, a reduction in speed is possible due to transmission path and cables used, down to 33600 bps V.34+). When operating a modem, it is imperative to configure the modem to blind dialling because most modems do not detect the dial tone of a telephone system. On modems that operate with the Hayes command set, blind dialling is set by means of the X0..X4 parameters.

Introduction

Important notes on using ISDN terminals

You may connect up to eight ISDN terminals to one S0 Bus of the telephone system.

ISDN terminals:

- AGFEO Digital System Telephones
- ISDN Telephones
- ISDN Cards
- ISDN Fax Machines

Depending on current consumption, you may connect at least four ISDN terminals that do not have a power supply of their own.

Example: 4 ISDN telephones or 2 digital system telephones plus 2 ISDN telephones.

All ISDN terminals must be approved ISDN terminals (DSS 1).

The internal S0 access is like a point-to-multipoint connection any available extension number from the system may be assigned to it. The 2 digit extension number will be treated like a multiple subscriber number (MSN). You can enter one or several of these MSN's in your ISDN terminal. If you should use this method, then please refer to the ISDN terminal's operating instruction. The multiple subscriber number is the ISDN -terminal's internal and Direct Dial Inward (DDI) number.

From an ISDN terminal, you call any internal extension free of charge by dialling the corresponding internal phone number. You can make external calls after seizure of an outside line by dialling **[9]** **[0]**. If the port is set to .spontaneous exchange line seizure with internal' then you must press the **[R]** button before dialling an internal number. If your Terminal has no **[R]** button or does not support this function then it will not be possible to make internal calls. ISDN telephones must use the same functions as analogue phones. For example you must press the star button before a function code is dialled. For ISDN phones that do not have a star button, you dial **[9]****[9]** instead.

To make an enquiry call you must have an R button on your ISDN telephone.

When programming the system, please ensure that the system confirmation tone is returned to you. If the confirmation tone is not returned or you receive an error tone, then you must re-enter the last entry.

The following can be displayed on your ISDN telephone:

- Caller's phone number (internal and -external)
- Connection charges
- Date and time after the first internal -connection

You can only make restricted use of the menu prompt functions.

Introduction

CTI - computer telephony integration

TK-Suite Client

With this Telephone System we included the Software Pack TK-Suite, this contains the CTI application TK-Suite Client. With this it will be possible to dial telephone numbers direct from your PC, see calls on your monitor and return calls direct from the missed call list. The capability can be looked up via the online help by pressing F1 on your PC at any time.

TAPI

Contrary to TK-Suite Client, the TAPI (Telephony Applications Programming Interface) is not an independent CTI application, but an interface between a TAPI-compatible Windows application and the telephone system. If the program or applications supports this then it will be possible to control the entire telephone system. The range of control is depending on the application you are running. However, in most cases you will be able to set up outgoing calls and display the arrival of incoming calls.

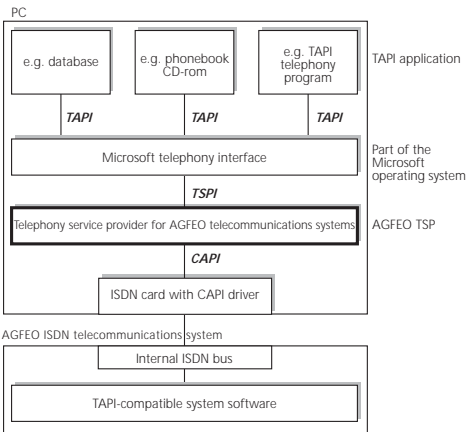

TAPI is an interface of the Microsoft operating system at the application end of Microsoft's telephone interface. A Telephony Service Provider (TSP) from the manufacturer of the ISDN hardware -in this case AGFEO -is needed to link this to the phone system. The TSP is a driver that must be installed on your PC to run the TAPI functions and to control the necessary exchange of data between the PC and telephone system.

Due to the constant increase of functions of these applications that support TAPI the TSP is always updated. To ensure that the latest version is available to you we provide this TSP totally free of charge on our Internet home page <http://www.agfeo.de>. The self-extracting file contains all the information needed for the installation of this program. Should you have no internet access, then please contact your Dealer.

Notes









CTI -computer telephony integration via TK-Suite Client or TAPI is only possible with analogue- or AGFEO System Phones.

Introduction





Pictograms and Buttons

All operations and functions of the telephone system is explained in clear and easy to follow pictograms.

Pictograms

	Ringer (tone ringing)		Conduct a call
	Pick up receiver		Replace receiver
	Dial Phone or Code Number		Conference
	Acknowledgement tone		Room monitor

Buttons

	Recall Button		Star Button for functions
	Number Button for entering digits, e.g. „9“		Hash Button to dial extension when automatic line seizure is active

System telephones

You may also use System Phones this will aid the ease of operation of your AGFEO ISDN Telephone System.

There are two different models available

-Digital ISDN System Telephone ST 25

-Digital ISDN System Telephone ST 30

The digital ISDN System Telephones ST 25 and ST 30 can be connected to any internal SO bus of the AGFEO Telephone System.

Up to two ST 25 or ST 30 can be connected to an internal SO Bus.

Please use the separate user manual on how to operate the AGFEO ST 30 Digital System Phone.

Installation

Safety Notes

- Installation and Maintenance of the System only by trained personnel.
- Important! To prevent personal injury and damage to equipment please ensure that the system is properly earthed and that the appropriate cable is connected in the mains plug.
- The System must be installed horizontal so that the connection panel is on the right hand side.
- Do not connect or disconnect any PSTN lines during a thunderstorm.
- Install lines and extensions in such a way that no one walks or trips over them.
- Disconnect the System from the mains supply before opening the connection panel.
Before connection of lines and extensions please ensure that the system is unplugged from the mains supply. DANGER!
- Preventive measure! Before carrying out any installation work, please touch briefly the PC/Printer socket of the telephone system. This will discharge any possible electrostatic charges, thus protecting the telephone system's electrostatically sensitive components.
- Do not allow liquids to enter the system as short-circuits may occur.
- No liability will be accepted for consequential damages such as an unintentional continued connection of a line.
- The telephone system will not operate in case of power failure and you will not be able to make any type of call.

The AS 35 is indented for the connection to Basic Rate ISDN lines (DSS1, Point to Point, System Access, or Point to Multi Point, Standard Access).

The AS 35 All-in-One can be connected to Basic Rate ISDN lines (DSS1, Point to Point, System Access, or Point to Multi Point, Standard Access) and may also be connected to analogue exchange lines.

Should you operate the AS 35 All-In-One on an analogue exchange line, then please ensure that your telephone service provider has meter pulse sending disabled as this may otherwise interfere with speech quality of a call.

You may connect any equipment which has been approved for the connection to the Public Switched Telephone Network (PSTN) to the extension port of the system.

Any DSS1 ISDN device which has been approved for the connection to the ISDN telephone exchange may be connected to the internal SO Bus. In addition you may connect up to two digital AGFEO System Phones to each SO Bus.

Any other use of the telephone system which is not listed or described is prohibited.

The telephone system has been issued with a universal connection licence.

The system fulfils the specified conformity and safety regulations.

Installation

Check contents of delivery

- 1 Telephone System
- 1 Installation material (3 Wall Plugs S6,3 Wood Screws,Phillips 4x40)
- 1 Analogue connecting Cable (AS 35 All-In-One only)
- 2 ISDN connecting Cables (IAE-single wires)
- 1 RS 232 PC connection Cable
- 1 USB Connection Cable
- 1 Template
- 1 Instructions Pack
- 1 CD-ROM with TK-Suite and the AIS Konfigurator

The operating instruction in PDF format can be found on our homepage www.agfeo.de

Select Location

Install the System in a dry room free of any hazardous materials. Avoid sites near Air Conditioners, Radiators, Equipment with excessive high radiation, direct sunlight, excessive dust and the danger of liquid spillages such as Water or Chemicals.

Ambient Temperature 5C to 30 C. Max humidity 70% non condensing.

The distance of the equipment to other objects such be considered to guarantee an air circulation. The minimum clearance distance of 50 cm should be adhered to. The distance of the system to the mains socket and the telephone network socket should not be more than 1 meter. (Length of mains cable 1.20 m)

It must be made possible to place a Laptop or PC near the telephone system for programming.

Mains Socket

A separate mains socket for the telephone system should be installed. This will assist to give uninterrupted service in case that a mains fuse is tripped. The power consumption of the telephone system is approx 50 VA.

Please ensure that the system cover is replaced before connecting the equipment to the mains.

Warning! The telephone system must be electrically earthed. Please ensure that the mains socket is properly earthed before connecting the equipment to it.

Installation

Wall Mounting

The system must be mounted on the wall so that the connectors are at the bottom of it. Use the mounting 1, 2, and 3 to fix the equipment to the wall.

- Use the template to mark the screw position.
- Before drilling ensure that there is no Mains, Water or Gas supply hidden in the wall.
- Use a masonry drill bit of 6 mm and drill to a depth of 40 mm,
or
- Wood Drill 3.5 mm Drill Depth 35 mm
- Insert Wall Plug and Screw, Screwhead distance from wall approx 3 mm.--
- Place the system on top of the screws and pull downwards until in place.
- Use last screw to secure system to wall.

Installation

Open Connection Cover

- Use a Screwdriver to press into the cut out of the connection cover.
- Pull the cover from the main housing in the direction of arrow

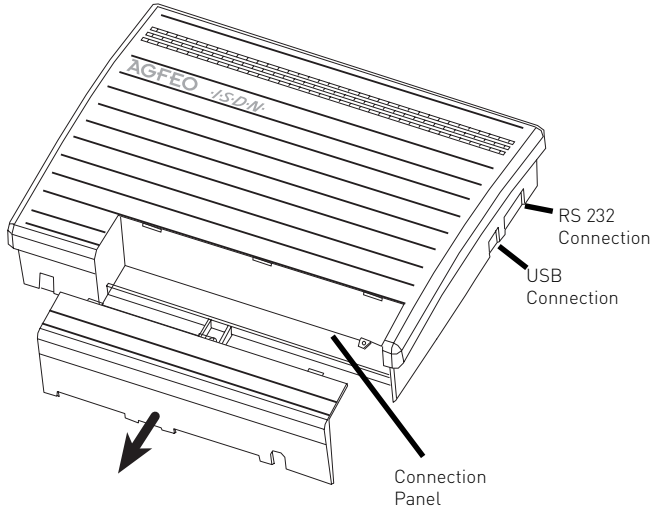

! Warning: Before opening ensure that the system is disconnected from mains supply!

Safety Notes

Please note the following:

- Before the installation or exchange of a module
- Before connection or disconnection of a line

1. Disconnect the System from the Mains Supply.
2. Disconnect all RJ Plugs of all external ISDN Lines either on the Network Termination Point or the SO Bus
3. With your finger touch the RS232 connection at the underside of the system to discharge any static electricity and to protect static sensitive components in the telephone system.

Installation

Connections of the AS 35

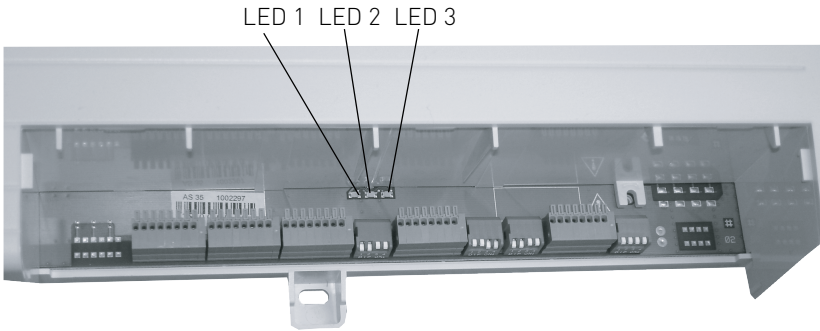

Opened Connection Panel of the AS 35

Connections of the AS 35 All-In-One

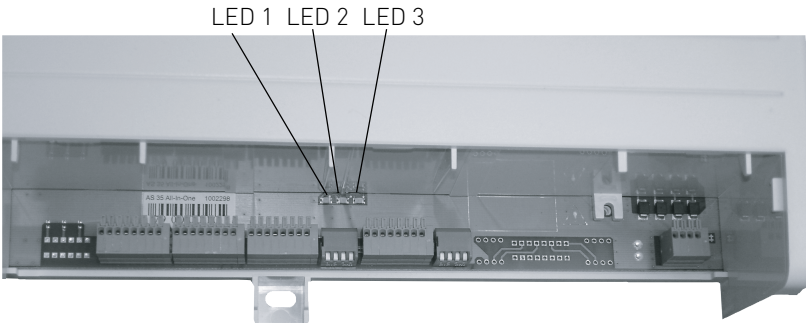

Opened Connection Panel of the AS 35 All-In-One

LEDs of the AS35 / AS 35 All-In-One

	Permanently lit	Flashes
LED 1 (green)	System is operational	System being initialised
LED 2 (red)		Data being transferred via RS 232
LED 3 (red)	System is connected to the computer via USB	Data being transferred

Installation

Connections of the AS 35

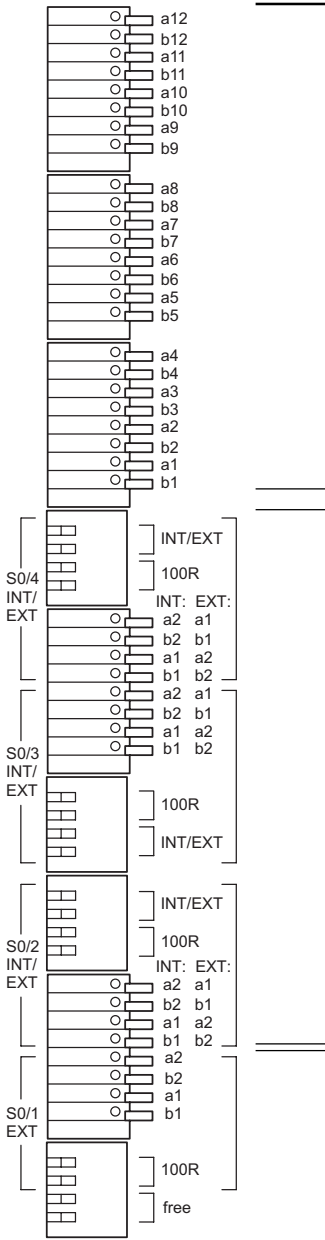

Note with reference to DIP switches:

The DIP switch settings for the S0 Busses are as follows:
 Towards PCB: Switchable S0 Bus is set to internal
 Away from PCB: Switchable S0 Bus is set to external

The DIP switch settings for the termination resistors are as follows:
 Towards PCB: Termination Resistor is set to ON
 Away from PCB: Termination Resistor is set to OFF

analogue extensions

switchable S0s

external S0

Installation

Connections of the AS 35 All-In-One

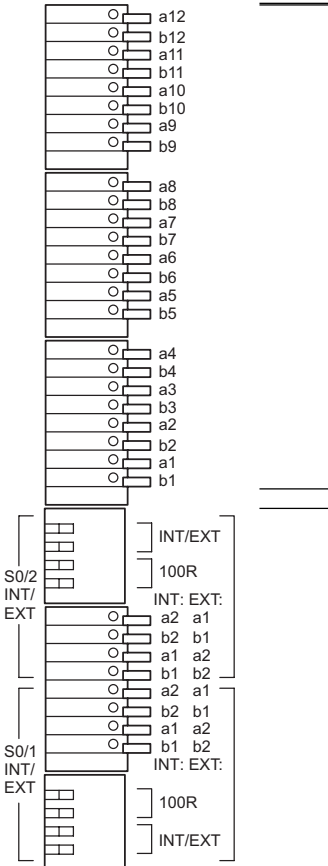

Note with reference to DIP switches:

The DIP switch settings for the S0 Busses are as follows:
 Towards PCB: Switchable S0 Bus is set to internal
 Away from PCB: Switchable S0 Bus is set to external

The DIP switch settings for the termination resistors are as follows:
 Towards PCB: Termination Resistor is set to ON
 Away from PCB: Termination Resistor is set to OFF

analogue Extensions

switchable S0s

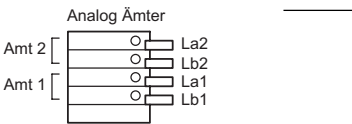

analogue lines

Installation

Connect Analogue Extensions

You may connect any analogue apparatus to the system which has been approved for connection to the public switched telephone network.

a/b-Apparatus is:

- Telephone (2 wire Phone or POT) either LD or MF Dialling with Timed Break Recall (TBR) (60 – 800 ms)
 - LD Phones may only have limited feature access.
 - Fax machines Group 3
 - Telephone Answering Machines
 - Modem 56k (V.90 to 56600 bps, may reduce to 33600 bps due to quality of lines V.34+)
- Connect the analogue apparatus via 2 wires to the a and b wire (Speech Pair) of the system port

Connection of wire

- Strip the cable by 11 mm.
- Push the single wire all the way into the connection block without pressing the release catch.
- To disconnect a wire, press the release catch with a small screwdriver while at the same time pulling out the conductor

External S0-Connection Fixed S0

System Access Connection

You can only connect a telephone system to a system access connection or also known as point to point connection. Other ISDN devices cannot be connected. The system can be connected directly to the NTTP via the enclosed ISDN Cable. You can also connect to a socket which is then connected to the NTTP.

Termination Resistors for the external S0 Connection

Both switches for the 100 Ohm Termination Resistors must be set to on for the System Access Connection.

Standard Access Connection

A Point to Multi Point connection may be installed as a S0 Bus type and up to 12 ISDN Sockets can be connected to this. The telephone system and up to seven additional ISDN devices may be connected to the S0 Bus.

Termination Resistors for the external S0 Connection

Both switches for the 100 Ohm Resistors must be set as follows:-

- **closed or on** if the connection is made directly onto the NTTP or on the last socket which has no 100 Ohm Termination Resistors fitted.
- **open or off** if the last socket has the 100 Ohm Termination Resistors installed or if the telephone system is not the last ISDN device on a PTMP line.

Connect the phone system directly with the ISDN connection cable to an ISDN socket of the S0 Bus or to the NTTP if the installation has no S0 Bus option.

Installation

Switchable SO Connections (internal or external SO-Connection)

External SO-Connection

You may connect the external SO Connection to a System Access (PTP) or Standard Access (PTPM) line. Please refer to External SO Connection (RJ45 Socket).

Use the enclosed ISDN Cable and connect the four wires to the SO connection block of the module.

- Push the wire all the way into the connection block without pressing the release catch.
- Connector: a1 -green
 b1 -brown
 a2 -yellow
 b2 -white
- To disconnect a wire, press the release catch with a small screwdriver while at the same time pulling out the conductor.
- Guide the cable through the cable comb.

Termination Resistors for the external SO Connection

System Access (PTP) –Both DIP Switches (Page 1-7/8) for the 100 Ohm Resistors must be closed or set to on. (Default Setting)

Standard Access (PTMP) - Both DIP Switches (Page 1-7/8) must be

- **closed or set to on** if the connection is made directly onto the NTTP or on the last socket which has no 100 Ohm Termination Resistors fitted.
- **open or set to off** if the last socket has the 100 Ohm Termination Resistors installed or if the telephone system is not the last ISDN device on a PTMP line.

Plug the ISDN Plug into the ISDN connection after completion of all installation work.

Installation

Internal S0-Connection

You can connect up to 8 ISDN devices like on a PTMP connection on the internal S0 Bus of the System.

ISDN Apparatus:

Digital AGFEO System Phones (max 2 digital phones per S0 Bus)

-ISDN -Telephones

-ISDN -PC-Cards

-ISDN -Fax machines

Up to four ISDN devices without additional power may be connected. For example: 4 ISDN Telephones or 2 Digital System Phones plus 2 ISDN Telephones.

Connections of further ISDN devices will need their own power source.

ISDN Apparatus must use the DSS1 protocol.

You will need the following material to install an internal S0 Bus.

Telephone wire CW1308 (minimum 2 pair) or CAT5 Cable

RJ45 Sockets max. 12 per Bus

2 Termination Resistors, 100 Ohm 0.25 W

Maximum S0 Bus length will be 130 m. (Telephone System to last RJ45 Socket)

Termination Resistors for the Internal S0 Connection

The internal S0 Bus must be terminated. Install two 100 Ohm Resistors in the last RJ45 Socket (See Diagram). Both DIP Switches must be closed (or set to on)

Colour Code for Telephone Cable CW1308

S0 Bus	Contact	Colour
a1	4	Blue/white Bands
b1	5	White/Blue Bands
a2	3	White/Orange Bands
b2	6	Orange/White Bands

Colour Code for T568B (CAT5)

S0 Bus	Contact	Colour
a1	4	Blue/White
b1	5	White/Blue
a2	3	White/Green
b2	6	Green/White

Colour Code for T568 A (ISDN)

S0 Bus	Contact	Colour
a1	4	Blue/white
b1	5	White/Blue
a2	3	White/Orange
b2	6	Orange/White

Most common used standard for S0 Bus installation is T568B (CAT5)

Ensure that pairs are not mixed up.

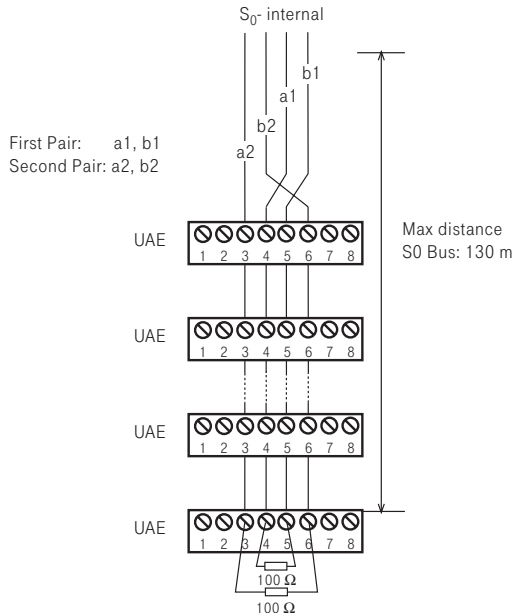

Installation

Connect the AS 35 All-In-One to an analogue exchange line

- Connect each wire of the line cord to the relevant port of the AS 35 All-In-One.
- Connect the plug to the socket of your telephone provider.

Please note that in difference to the ISDN line the analogue exchange line is unable to send call progression. As such the calling party will not receive a confirmation from the telephone network if the called party has answered. Therefore there will be the following difference between analogue - and ISDN line.

- From the time the exchange line has been seized by the relevant extension will be the time the call will be logged as to have started, even if the called party is busy or does not answer.
- MF over dialling is possible but will not be recognised by the system as such. This will result that the dialled telephone number including over dialled number will be stored in the call log and last number redial.

Installation

Door Phone

It is possible to connect a door phone to the extension port of the telephone system. This analogue door phone will receive the control signals as DTMF tones. To use such a door phone you must set the relevant extension port to door using TK Suite, section "System Telephones", drop down menu "Phone Type".

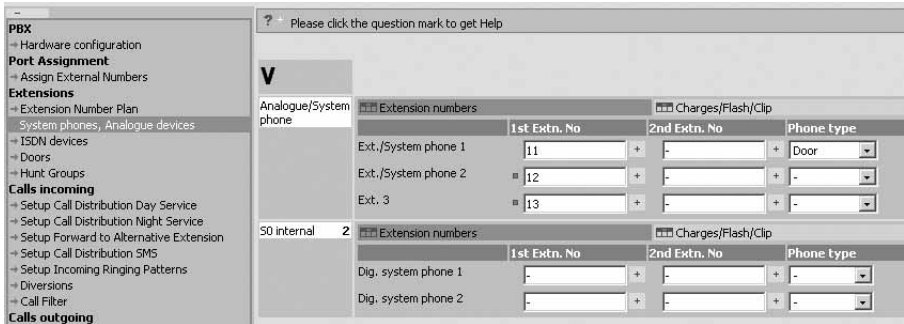

In addition you must assign an extension number for the relevant bell push buttons. This setting you will find under "Doors". Up to 4 Bell Push Buttons are supported for one door phone. After this you would have to set the relevant DTMF digits to operate the door phone, these you will find in the user manual of the door phone.

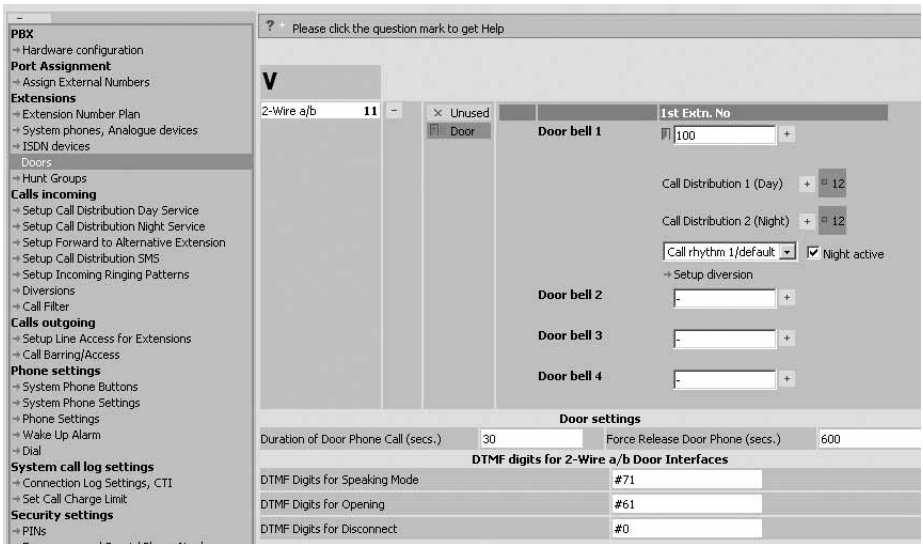

Installation

Commissioning

You have installed the system. However, before you can make a call you must do the following:

- Connect the extensions. You may connect any apparatus which you are allowed to connect to the public switched telephone network.
- Connect the RJ 45 plug to the ISDN network or connect the relevant connection cable to the analogue network. (Analogue Network AS 35 All-In-One only)
- Switch on the telephone system by plugging the mains plug into the mains socket.

Programming to the users requirement can be carried out via the connection of a PC. The remote programming of the system may be carried out via your dealer.

Notes

To avoid calling wrong telephone numbers please ensure that the following is carried out. After installation of the system please dial from an analogue MF telephone a single digit, this ensures that the system recognises the correct dialling method for the relevant extension. Should you change to a telephone which is dialling in LD, then you must dial a digit higher than 2. Should you operate two telephone on one port, then you must ensure that both phones connected are of the same dialling method.

Installation

Default Settings

Listed below are the default settings:

AS 35

- The Termination for external S0 Connection is closed, the 100 Ohm terminating resistor is switched on
- Switchable S0 connection S0-2: set to external, the 100 Ohm terminating resistors are on
- Switchable S0 connections S0-3 and S0-4: set to internal, the 100 Ohm terminating resistors are on

AS 35 All-In-One

- Switchable S0 connections S0-1 and S0-2: set to internal, the 100 Ohm terminating resistors are on

Both Systems

Extensions: 11, 12, 13, 14, 15, 16, 17, 18, 19, 20

All users set to: Telephone

External line access: unrestricted for all extensions

Line access with 9

Day Service 1 no entry

Night Service 2 no entry

Call diversion internal: off

Do not Disturb: Off for all extensions

Call waiting: off for all extensions

transmission of own number to called and calling party: set to on

Music on Hold: Internal off

Automatic dialling: off

Printing of call records: off for all extensions

Printing of dialled phone number: without

Cost limit: No entry

Charge unit factor: 0,061

Base factor: 0,061

Disconnect on Cost limit: off

Program access code: off

Switchbox number: no entry

Busy on Busy: off

Prefix 0 to call from call log via internals S0 connection: off

System Phones:

-Display Call Charges:off

-Display:english

-Call Log:off

-Pop Up Menu : on

Installation

Tecnical Data AS 35

Specification	ISDN Telephone System
Basic Confioguration	1 external So Connection (PTP or PTMP) 3 SO connections switchable internal / external 12 Analogue Extensions (POT's)
Measurements	8,1 x 32,2 x 24,4 cm (High x Width x Depth)
Weight	1,6 kg
Ambient temperature - Operation/Storage	5 °C to 40 °C / -25 °C to +70 °C
Humidity	max. 70 % (none condensing)
Mains Connection - Power Consumption	230 VAC, +/-10%, 50 Hz $P_{max} = 35 \text{ W}$
External S0 Connection fixed Switchable Connection	PTP or PTMP connections, Euro ISDN 2e via RJ 45 Socket and enclosed connection cable SO connection internal / external switchable (DIP Switches) external: PTP or PTMP connection Euro ISDN 2e (DSS1) internal: PTMP connection, Euro ISDN 2e (DSS1)
- Connection	4 wire spring loaded connectors
- Length	max lenght of internal S0 Connection: 130 m
- Power Consumption internal S0	4,5 Watts
- ISDN-Apparatus	max. 8
Analogue Apparatus	max. 12
- Distance	2 x 50 Ohm (diam. 0,6 mm, 800 m)
- Connection	2 wire spring loaded connectors
- Dial Method	DTMF or LD
- Enquiry Button	Flash (80 - 600 ms).
PC/ Printer Connection	RS 232C
- Range/ Level	3 m / +/- 5 V
- Connector	9 pin D-Socket
USB Connection	Universal Serial Bus
- Cable Length	3 m

Installation

Technical Data AS 35 All-In-One

Specification	ISDN Telephone System with 2 external analogue lines
Basic Configuration	2 SO connections switchable internal / external 2 external analogue lines 12 Analogue Extensions (POT's)
Measurements	8,1 x 32,2 x 24,4 cm (High x Width x Depth)
Weight	1,6 kg
Ambient temperature - Operation/Storage	5 °C bis 40 °C / -25 °C bis +70 °C
Humidity	max. 70 % (none condensing))
Mains Connection - Power Consumption	230 VAC, +/-10%, 50 Hz $P_{\max} = 35 \text{ W}$
Switchable Connection	SO connection internal / external switchable (DIP Switches) external: PTP or PTMP connection Euro ISDN 2e (DSS1) internal: PTMP connection, Euro ISDN 2e (DSS1)
- Connection	4 wire spring loaded connectors
- Length	max length of internal SO Connection: 130 m
- Power Consumption internal SO	4,5 Watts max. 8
- ISDN-Apparatus	
Analogue Apparatus	max.12
- Distance	2 x 50 Ohm (\varnothing 0,6 mm, 800 m)
- Connection	2 wire spring loaded connectors
- Dial Method	DTMF or LD
- Enquiry Button	Flash (80 - 600 ms)
PC/ Printer Connection	RS 232C
- Range/ Level	3 m / +/- 5 V
- Connector	9 pin D-Socket
USB Connection	Universal Serial Bus
- Cable Length	3 m

System Telephones

System Telephone ST 25

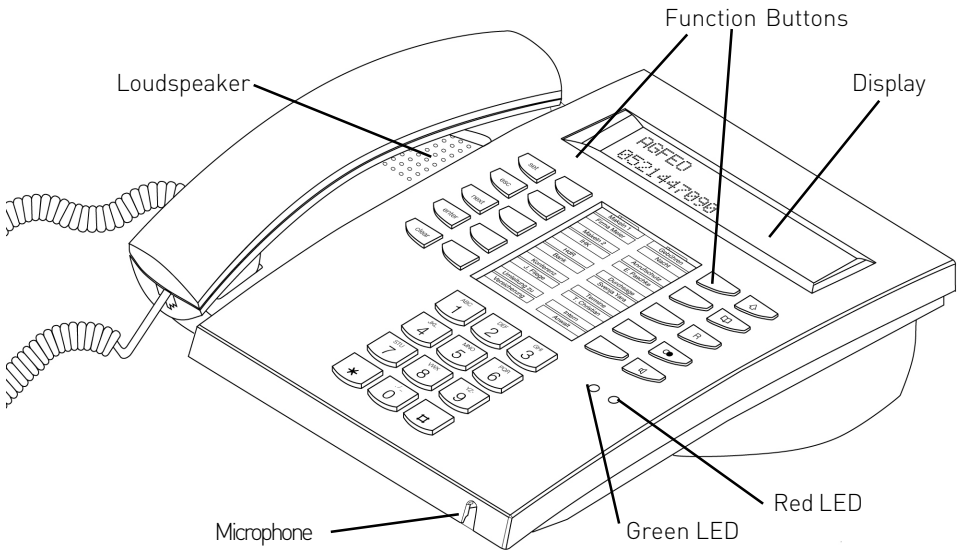



 Numeric Keypad

 # and * Buttons

 Set Button for initiation and ending of program functions

 esc Button - for clearing a connection or for cancelling programming mode

 next Button - for scrolling further in the display in the event of different functions

 enter Button - for confirming inputs

 clear Button - for clearing a display or data

 shift Button - to use the second level of function keys and to switch the phonebook register mode (numeric / alphabetical). Change between small and capital letters.

 Telephone Directory Button: To list stored numbers

 Recall Button - to make an enquiry or brokers call

 LNR Button - Last Number Redial

 Handsfree Button - To activate Loudspeaker

 10 Function Buttons - These Buttons have default functions assigned to them which can be changed via programming

Red LED - Flashes on appointment call or missed call. Lights up when DND (do not Disturb) is set

Green LED - Flashes when hands free mode is on, lights up by operating a headset.

System Telephones

System Telephone ST 30

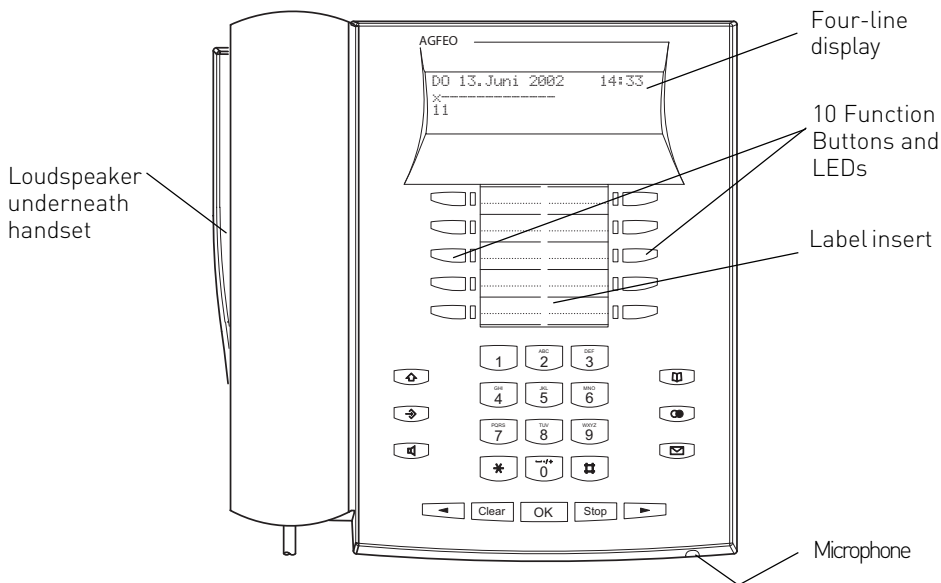



  Numeric Keypad

  * and # Buttons

 Shift Button - To access second level of function buttons to alternate between different modes of Phone Book retrievals and to change between upper and lower case letters.

 Set Button - Start and end programming

 Handsfree Button - Activates the Loudspeaker. Button lights up when activated.

 Arrow Buttons - To scroll through the display where there is more than one function.

 Clear Button - Clear an entry

 OK Button - Confirm inputs

 Stop Button - disconnect or cancel an action

 Phone Book Button - Retrieval of Telephone Numbers.

 LNR - Last Number Redial Button

 Mail Button - Flashes on new entry in call log or missed calls. Stays lit for numbers already viewed. Clears when number is called or deleted from list by pressing clear button

 10 function Buttons - User programmable, two entries per Button (First & Second Level) LED indication only for first level.

System Telephones

Setting up and cleaning the system telephones

Please find a suitable location for your phone and avoid any areas where it may be likely for water or chemical spillages to occur.

Plastic feet of the phone:

The phone as been produced for normal use.

The feet of the apparatus may alter when in contact with chemicals, such as furniture polish or other cleaning agent and could leave marks on surfaces. No liability will be accepted if this should occur. It is therefore advisable to place the telephone on a non slip matt to protect furniture from marking.

Cleaning

The cleaning of your telephone is relatively easy if you note the following points:

Please wipe the phone with a damp or anti static cloth.

DO NOT USE a dry cloth (as a static discharge could damage components in the phone)

Ensure when cleaning that no liquids will enter the housing as this could damage switches and contacts.

Insertion of label strips for function buttons

Place your nail between the insert and telephone housing at the top. Then pull down the clear insert so that it is bending outwards.

You now can remove the label insert. Insert the new label and replace clear cover. Insert bottom end first, bend outwards and then insert into top slot.

All labels can be printed direct from your PC with the use of TK-Set. This will aid to give your phone that professional look.

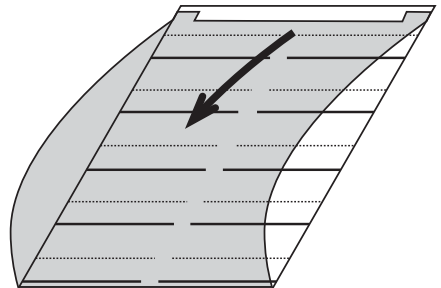

System Telephones

System Telephones - settings

ST 25

ST 30

You can alter the following settings on your System Phone:

- Tone Ringer - Volume and Pitch
- On Hook / Handsfree Volume
- Display Contrast – to set optimum viewing angle
- Handsfree microphone – Automatic activation on Voice Alert
- Headset and Handset Volume (ST 25 and ST 30)
- Telephone Lock – Your Phone will be barred from making calls
- Display of call charges
- Status display (Extensions and Lines) and or Date & Time
- Set Call Log
- Set access to outside line -direct or with access digit

Setting of Date & Time is done by the ISDN Network (Not available from UK Network Providers)

Setting the Ringing volume

Press SET 21 to alter the Ringing Volume

Available Values 1 - 7

Meanings:

1 -very low

7 -very high.

You hear a short ring in the volume selected.

Exit Programming.

Your phone will ring at the newly set value.

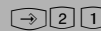

Setting the Ringers Tone or Pitch

Press SET 22 to alter the Pitch.

The current setting is displayed.

Enter the new Value

Meanings:

1 -very slow

7 -very fast.

You hear a sample ring.

Exit programming.

Your Phone will now ring with the selected tone.

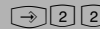

System Telephones

Setting the Display Contrast

Press SET 231 to alter the display contrast. The current setting is displayed

Enter the new value
2 - 7

The contrast changes immediately.
Exit programming.

ST 25

ST 30

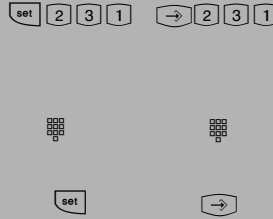

Handsfree Microphone - Set to Auto on

Press SET 244 to activate automatically the Handsfree Microphone. The current setting is displayed.
Press 1 to activate automatic activation or 0 to switch off
Exit programming.

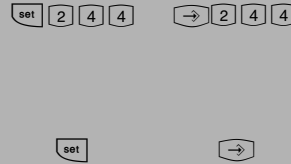

Setting the Speaker Volume

Press SET 251 to set the Speaker Volume. The current setting is displayed.
Enter the value required 1 to 7
1 -very low
7 -very high.

Exit programming.

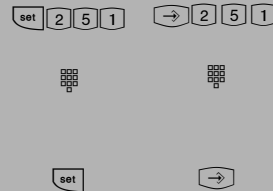

Setting the Headset Volume

Press SET 252 to set the Headset Volume. The current setting is displayed.

Enter the new setting from 1 to 5
1 -very low
5 -very high.

Exit programming.

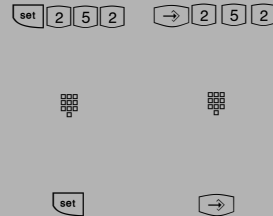

System Telephones

Telephone Lock (PIN)

ST 25

ST 30

Every system telephone can be locked with a PIN number (see 'Telephone lock -emergency /direct call ').

No calls can be made except numbers which have been stored in the * and # location and the auto dial number. To prevent locking or unlocking of the phone please use a PIN number.

To program PIN Number Press SET27

If necessary clear any existing code first
Enter new 4 digit PIN number
Exit programming

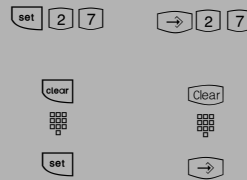

Cost display

Press Set 28 to switch the display of call charges on or off.
The current setting is displayed.

Press 1 for on or
2 for off

If the current setting is set to off then the Time will be displayed. If it is set to on, the charges will be displayed for 5 seconds after each receipt of a charge pulse from the exchange. At the end of a call the cost is displayed for 20 seconds before the display returns to show the date & time.

Please note that this service may have to be requested from your network provider as indication of call charges during or at the end of a call. (This service is not available from the UK network providers)
Exit programming.

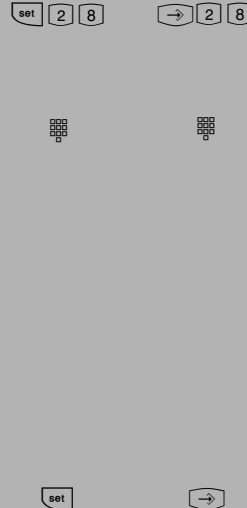

IMPORTANT NOTE:

On using analogue lines, call charges cannot be displayed or calculated!

System Telephones

Status Display & Date/ Time

To set the status display of the S0 's:
 Select a free space in the display with "next", confirm with "enter", select the S0 whose status is to be displayed with "next", confirm with Enter.
 Set other S0 or exit programming with set.

Setting the status display of the internal number:
 Select a free space in the display with "next", enter the internal number whose status is to be displayed.
 Set other internal number or exit programming with set. If you have not entered an internal number you have an undefined status display.
 To clear a position, select this with "next", and clear with "Clr" and confirm with "Enter".
 In the DECT 30 you can only clear all status entries together.

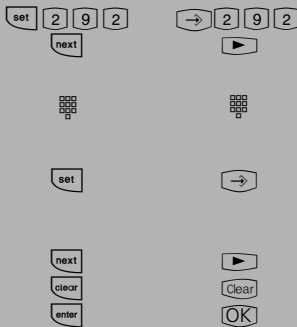
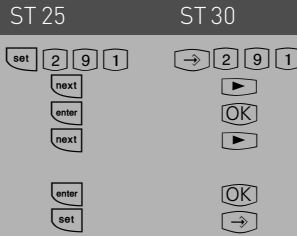

Set Date & Time

You can set the Date and Time with the following procedure:

Start Programming with: *705

Set Time with:

Set Date with:

End Programming with: *700

*7381 HHMM

*7382 DDMMYY

To Set Date & Time

Under normal circumstances you do not need to set the date and time as this is done automatically from the ISDN network when a call is made. Winter and Summer times are also set automatically. However, this service is not available from the UK network providers and therefore the system has to be user set.

System Telephones

Call Log

ST 25

ST 30

If an incoming call is not answered then the called number, date and time are recorded in the Call Log. This is providing that the number is not withheld. Calls can be returned by the touch of a button or removed from the Call Log. Unanswered extension calls, can if so required add their extension number to the Log.

Programming:

The Call Log can be switched on or off and settings can be made if the number or also the name, if in the Phone Book, is to be logged. Alternatively it is also possible to create a Call Log for callers which are stored in the Phone Book. In this case all none stored numbers are ignored.

Call Log ON / OFF

Press SET 2* to set the Call Log. The current setting is displayed



Enter new setting

0 = switch off logging of external calls
1 = switch on logging (All Calls with name & number)
2 = Names only, which are stored in Systems Phone Book



Exit programming



System Telephones

External Line Access

ST 25

ST 30

Depending on your preference the system offers different modes to connect to an outside line. Spontaneous seizure with internal will connect any number dialled to the exchange line. To dial an extension you prefix the extension number with #. If your phone has no # button then you are unable to make any internal calls. If you set the access to spontaneous then on lifting the receiver you will hear external dial tone. With this setting you cannot make any internal calls. This setting could be used for a faxmachine or a payphone. If you select the setting with access digit then you have to dial 0 (or 9) to get an outside line. In this case you would dial 9 and the required telephone number or the two digit extension number to make an internal call.

Setting External Seizure

Press SET 2# to set outside line seizure. The current setting is displayed.

Enter the following digit
1 =direct access on (spontaneous external seizure with internal)
0 =direct access off (external seizure with „0“ is on)

Exit programming



Allocate an Extension Number

You can set an extension number from your telephone.

Press SET 91.
The allocated extension numbers are displayed.
Enter the required extension number

Exit programming.



System Telephones

Overview of freely programmable Function Buttons

TAM activation	To switch TAM module on or off of the ST 30 System Phone.
TAM info	To listen to messages recorded on the TAM.
TAM Memo	To record messages on the TAM
Reject	Reject the ringing call. Caller will hear busy tone.
Call Waiting Deny	Switch Call Waiting on or off Special Function Buttons can be assigned Call Waiting Deny for 1 st Extension Number Call Waiting Deny for 2 nd Extension Number Call Waiting Deny for 1 st and 2 nd Extension Number
Call Filter	To switch Call Filters on or off.
Do not Disturb (DND)	This will switch off the Tone Ringer Special Function Buttons can be assigned: -DND for Calls to the 1st Extension Number -DND for Calls to the 2nd Extension Number -DND for Calls to the 1st and 2nd Extension Number -DND for Extension Calls -DND for External Calls -DND for all Calls
Night Service (AVA 2)	To switch Night Service on or off Special Buttons can be assigned -Night Service separately switchable for each line -Night Service for all lines
Call Forwarding	Switch on or off Call Forwarding Feature Special Buttons can be assigned -Switch for each incoming line of the system separately -Switch for all incoming lines of the system together
Tannoy	Announcement via Public Address Amplifier connected to the Telephone System
Busy on Busy	Return Busy Tone to Caller if one Extension is Busy within Call Distribution Group. Special Buttons can be assigned -Busy on Busy for each Call Distribution Group switchable separately -Busy on Busy for call Call Distribution Group switchable together
Call by Call	To select Network Provider via LCR
Check In/ Check Out	Start / Stop the Call Cost at the touch of a button.
clr (clear)*	delete entries
Page (Tannoy)	Pageing Announcement to System Phones. Programmable function Button - Page specific Extensions.
Units	Display Call Cost
Call Capture	Malicious Call Identification via ISDN-Exchange
Remote functions	Sending of stored DTMF Tones (1..0 * #) for a remote interrogation of a Telephone Answering Machine (TAM)
Remote Answer	Possible to make the ringing extension go off hook from another phone.
Group Button	Log in and out of Groups and their features
Headset	To use a Headset (only Digital System Phones)

System Telephones

Overview of freely programmable Function Buttons

Call Pick Up	To Pick Up incoming calls. Special Function Button can be assigned to Pick Up internal and external calls from specific extensions.
Withhold	To withhold own number to be sent to a called party.
Internal Button	To Dial Extensions. Special function Button programmable: Call specific Extension
ISDN-Hold	To Hold an external call in the Telephone Exchange (only available on PTMP connection)
ISDN-Call Forwarding	To switch on or off the ISDN Call Forwarding feature.
Conference	To set up a Conference Call with Internal and or External calls.
Speaker Volume	To set the Speaker Volume Level for Handsfree or On Hook use.
LCR	To switch Least Cost Routing (LCR) on or off for your System Phone.
Call Split	To talk to more then one External Call in turn. (Switch between them)
Brokers Call*	To talk to one internal and one external call at a time and without connecting them.
Memory	To store an external number displayed in the LCD.
External	To transmit another of your MSN numbers other the the one allocated to the Extension making the call. A special Button can be assigned for this feature.
Relays	To switch a Relays. A special function Button can be assigned.
Reserve	To reserve a line should all lines be engaged at the time.
Enquiry Call*	To establish or set up an Enquiry Call, a connection or a Brokers Call
Telephone Book*	To select a number out of the System Telephone Book
Telephone Lock	To Lock the System Phone and activate pr-set Emergency and Direct Call numbers.
Appointment	To set or cancel a preset Appointment Time
Timer	To switch on or off a Time based function, such as Day-Night Service, Call Forwarding, Relays etc. Button can be assigned for this function. 10 Timers are available. Timers are form 0 to 9.
Doorphone and Lock Release	Function Button can be assigned to connect to the Doorphone. Another Button can be assigned to activate Lock Release.
Transfer	To transfer and connect an external call to an external call.
Diversion from (Follow me)	To divert calls from another extension to a selcted extension.
Diversion to	To divert calls to another Extension or Outside number.
Wake Up	Set or cancel wake up time.
Call Deflection	To forward an incoming call during the ringing sequence to another number without having answered this.
Destination Button	To Call a preset Telephone Number
- Public	- This number is stored in the Telephone System Memory
- Private	- This number is only stored in your telephone
	Note: *These are fixed Buttons available on the System Phones.

System Telephones

Button Assignment

ST 25

ST 30

On delivery of the Phone System all programmable function Buttons of the Phones have a default setting which are the same on all System Telephones. These Buttons can be individual programmed to suit your specific needs. Each of the 10 Buttons can have a function allocated to it, which you can activate by just pressing the Button. In addition each of the function Buttons have a second level. To activate the second level you must press the Shift Key before pressing the function Button.

Default Setting:

Brokers Call	Units
Destination public	Destination public
Reject	Memory
Destination public	Destination public
Pick Up	Page
Destination public	Destination public
Conference	Transfer
Destination public	Destination public
Diversion to	Intern
Destination public	Destination public

Changing Button Assignment

SET 31: Initiates Programming.

Press the function Button you like to change (if necessary,press the "shift "Button to reach the second level)

The current function is displayed.

Enter the first letter of the function 's name,or,

by pressing the "next " Button,scroll down until the desired feature is displayed

or

By pressing the "shift "and the "next "Button, scroll up until the desired feature is displayed, i. e. wake up

Press Enter to confirm the selection and to program another Button otherwise

Press SET to end programming.

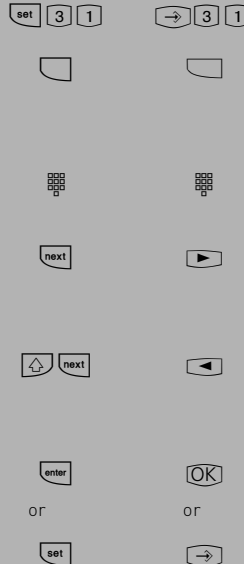

System Telephones

Button Assignment of Specific Functions

ST 25

ST 30

As described earlier (Change Button Assignment), start programming mode with SET 31 and select Button and required function.

„Do not disturb“ Function Button

Press ENTER:to confirm selection.
Enter the phone number to which Do Not Disturb should apply:
1 = First internal phone number
2 = Second internal phone number
1 & 2 = First and Second internal phone numbers
Press ENTER to confirm
Enter the call mode to which Do Not Disturb is to apply:
1 = internal calls
2 = external calls
1 & 2 = internal and external calls
Press SET to end programming.
You now can turn this feature on or off by just pressing the allocated Button.

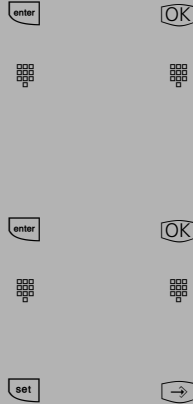

Call Variant 2 (Night Service) Call Variant 3 (Call Forwarding)Function Button example based on Call Variant 2

Press ENTER:to confirm selection.

Press NEXT to select the Number or Name of SO Line to which this feature should apply. If this feature should apply to all lines or the line number is to be entered prior to activation then select All or General

Press SET to end programming

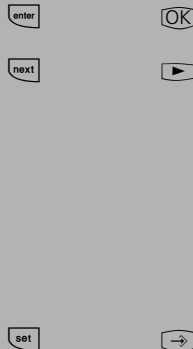

System Telephones

Announcement Button

Press ENTER:to confirm selection. Enter the Extension Number or Group Number who should receive the announcement. If you do not enter a number then this can be selected after pressing the Announcement Button. When pressing the Announcement Button and no Extension number is entered then all System Phone Extensions will hear the Announcement. Press SET to end programming

ST 25



ST 30



Remote Answering

Press ENTER:to confirm selection
Enter the Extension number for which this feature should be activated when pressing this Button. Press SET to end programming



Notes

Remote Answering can activate a particular Extension to go off Hook. For example: You could have a System Phone on your Desk but you also have a DECT 30 with Headset. A call arrives on your DECT 30. By pressing the Remote Answer Button on your Desk Phone your DECT 30 goes off Hook thus having answered the call. To use this feature external dialling must have been activated on the phone for which it will be used. Remote dialling can be used in a similar manner.

Group Button

Press ENTER:to confirm selection
Enter the required Group Number to which your Extension should be assigned.
Press SET to end programming



Call Pick Up

Press ENTER:to confirm selection
Enter the extension number of the extension from whom you like to pick up calls.
Press SET to end programming



System Telephones

Notes

ST 25

ST 30

When using the functions Announcement and Call Pick up for more than one extension, then please form a Group and enter the Group number instead of the Extension. You can also assign the same of the first or second extension number to several extensions and form a Group this way. With reference to the Call Pick Up function, if you do not define an extension number, then you can only Pick Up external calls.

Intercom (Specific Extension)

Press ENTER:to confirm selection



Enter the two digit Extension number you like to call when pressing this Button.



Press SET to end programming.



Notes

If you assign the Extension of a Telephone Answering Machine, then you can Pick Up the call even after the Machine has answered it. This is providing that the Port is set to Answering machine. If no extension has been set on the Intercom Button, then you can dial any extension after this Button has been pressed.

MSN CO Button

Press ENTER:to confirm selection



Press NEXT to select line to which this Button should apply or General if you want to select the line after this function Button has been pressed.



Press SET to end programming



System Telephones

Relay

ST 25

ST 30

Press ENTER:to confirm selection



Enter the relay that you wish to switch with this Button (Extension Number of Relay)
Press SET to end programming



Note

If no Extension Number of the Relay has been set then the programmed Button will be allocated a 'General' status which means you must select a relay number after you have pressed this button.

Door Phone and Lock Release

Press ENTER:to confirm selection



Enter the door that you wish to operate with this Button (Extension Number of Doorphone)



Press SET to end programming



Notes

If no Extension Number has been assigned for the Doorphone Button, then you must enter the required Doorphone after pressing this Button.

System Telephones

Making a Call

To make an internal call, pick up receiver and dial the 2 digit extension number. Note: Each extensions can have two seperate numbers. Please contact your Telephone System Manager for an Internal Telephone Directory.

To make an exchange line call depends on how your telephone system is programmed. For users who's extension is set to 'Spontaneous line seizure with internal' just need to dial the the required telephone number. If you would like to make a call to another extension on your telephone system, then please prefix the extension number by #.

If a line access digit is set then you have to dial 0 (or 9 as the case may be) to get an outside line and then dial the telephone number required. If you would like to call another extension on your system, then just dial the two digit extension number.

If Call Forwarding is active on your line, then you will hear a special dial tone from the telephone exchange after you connect to the line. This will remind you that this or another feature may be set in the exchange

System Telephones

Make a Call

Spontaneous seizure with internal

Lift receiver, your extension number will be displayed.

ST 25

ST 30



Calling an internal user

Press the 'Internal or Intercom' Button and dial the required extension number.

If programmed the name of the called extension is displayed.

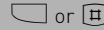

Calling an external subscriber

Just dial the telephone number required. The telephone system automatically seizes an outside line.

If the telephone number is different from the one dialled then it will be displayed in the LCD. (This Service may have to be enabled from the network provider (COLP))



Calling an external number (Using access digit)

Lift receiver, your extension number will be displayed.



Calling an internal user

Dial the Extension Number only



Calling an external subscriber

Dial 0 (or 9 if applicable) to get a line



On hearing external dial tone dial required telephone number



System Telephones

External Access with MSN Button

Press the MSN CO Button

Press "next" to select the phone number or name of the line you wish to access.

Press "enter" to confirm selection.

Dial the required telephone number.

Pick up Receiver or press Handsfree Button the call will be connected.

ST 25

ST 30



External Access with special MSN Button

Lift receiver, your extension number will be displayed

Press the MSN /external Button to seize an outside line.
Line name and number may be displayed.

You now will hear external dial tone and can dial the number required.



Reserving an Outside Line (Call Back when free)

On requesting an outside line you will hear busy tone if all lines are engaged. You may now request for a line to be reserved. As soon as an outside line becomes free the system will phone you back. When picking up the receiver you will hear external dial tone and can dial your number.

System Telephones

Reserving an Outside Line (Call Back when free)

On hearing busy tone while dialling number press the enter Button to reserve an outside line.

Replace Receiver.
The Telephone System will call you back as soon as a line becomes available.
Pick up Receiver, you will hear external dial tone.
Dial number required.

ST 25

ST 30



((D>))



((D>))



Notes

Barred Calls – You will not be able to make calls for which your extension is call barred. If you try and make a call to a barred number, error tone will be returned to you.

DTMF signalling –Is possible to send DTFM Tones during a connection. This can also be done during an enquiry call, Brokers Call and Three Party Conference. Any digit from 0 – 9 including * and # can be transmitted.

Prepare for dialling -The receiver is on the hook. Enter the phone number.The number entered is displayed. The call will be connected as soon as the receiver is picked up or the handsfree button is pressed.

On Hook Dialling-Press the “loudspeaker” button and dial the phone number.Lift the receiver once the other party answers.

Handsfree -Instead of lifting the receiver, you can also press the “loudspeaker” button and have a handsfree telephone conversation. Handsfree mode is turned off when you pick up the receiver. To switch to handsfree again press the speaker button before you replace the handset. To end the call press the speaker button.

Call Monitor – Press the speaker button if you want other people in the room to hear your telephone conversation. People in the room can listen to the other party via the speaker while you continue your call as normal.

System Telephones

Accepting Incoming Calls

ST 25

ST 30

Due to a different ringing you are able to differentiate between extension -, incoming and doorphone calls. You can also see who is phoning you before you answer the call.

Internal call :The Display is showing the extension number and name.

External call :The first line of the display will show the caller 's number or the name if this is stored in the systems telephone book. Indication on which line the call came in is also given. If a particular line has been given a name ie. 'Any Company' then this will also be displayed. This will ensure that the call is always answered with the correct company name in a multi company set up. If more then one phone is ringing for an incoming call then the one to pick up first the receiver is connected to the call.



Call Waiting

You can receive a second call while already on a call. If this happens you will hear a Call Waiting tone in your receiver. You can accept or reject the waiting call. Example: You hear the external call waiting tone, the second line in the display shows the identity of the waiting caller. Accepting the second call:



First Option

replace the receiver to end the current call.Your telephone will ring for you to answer the waiting call.



«(D)»

«(D)»



System Telephones

Call Waiting

Second Option - press the Split Button. The first call is placed on hold while the waiting one is connected to you. You can alter between the calls by pressing the Split Button. You can also deflect the waiting call.

ST 25

ST 30



Rejecting the waiting call

Press the Reject Button. The caller will now hear busy tone if you are the only phone programmed to ring on an incoming call. If there are also other phones programmed to ring on an incoming call then the caller continues to hear the ringing tone. Continue your original call.



System Telephones

Call Transfer

ST 25

ST 30

You can transfer an incoming call to an extension or another external number. When transferring a call to an extension you can announce the caller before replacing the receiver.

Internal Transfer with announcement

If you are on an external call and would like to transfer this to an extension then please press the Internal Button or Recall Button and dial the required extensions wait until it answers, announce the call and replace the receiver.

If the extension does not answer or is busy then press the 'Split' or the 'ESC' Button.

You may transfer the call to another extension if the original extension does not answer.

You may also park the call by pressing the Enter Button and replace the receiver.

You can retrieve the call from any other System Phone by picking up the Receiver and press the Enter or OK Button.

You can Camp on a transferred call. As soon as you hear the ringing tone, replace your receiver.

As soon as the called extension becomes free the call will be connected automatically.



System Telephones

Call Transfer without announcement

You are on an external call and would like to transfer this to another extension.

Press the Intern Button and dial the required extension number. The external call is placed automatically on hold and if so programmed will hear Music on Hold. Replace the receiver before the called extension answers.

The display of the called extension will show the telephone number and if applicable the name of the calling party.

The called extension is connected to the transferred call as soon as the receiver is picked up. You will receive an immediate call back if the called extension is busy or the Do Not Disturb feature is activated. The call will also be returned to you if the extension has not answered the call within 45 seconds. Ringing of your extension will be cancelled if you fail to answer the returned call within 60 seconds.

ST 25



((D>))

ST 30



((D>))

External Transfer

You are on a call to an external number and would like to transfer this call to another external number.

While speaking to the caller press the SPLIT or BROKERS CALL Button (The external call is put on hold and if so programmed will hear Music on Hold) dial the required telephone number and talk to the new party. You can talk in turn to each of the external parties by pressing the SPLIT or BROKRS CALL Button. To connect the two external calls press the transfer button (This must have been programmed) Replace your receiver.



Notes

External Call Transfer is only possible if one of these is an incoming call. This feature will use two outside lines. You will be charged for the outgoing part of the call.

System Telephones

Transfer an Outside Line

ST 25

ST 30

You can give an extension an outside line. This is useful in cases where the extension is not allowed to make outside calls. The extension can phone the system operator who can transfer a line. Note you will transfer a line with your Class of Service.

Transfer an Outside Line

Extension calls you and asked for an outside line. Press the Brokers Call Button or the Split Button. You hear external dial tone now press the Transfer Button and replace the receiver. The calling extension can now make an outside call.

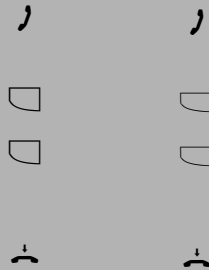

Call Waiting / Callback when free

An extension already on a call will hear a call waiting tone in their handset when you call it. If the called extension replaces the receiver then the waiting call will ring immediately at this extension. You can initiate Call Back when Free if the called extension does not accept your call.

Requesting Ring back when free

On hearing the busy tone when calling an extension, press the ENTER or OK Button. Call back when free has now been initiated. As soon as the busy extension becomes free your phone will ring as soon as you pick up your handset the other extension will be rung.



System Telephones

Callback

When Call Back when free is set, your phone will ring as soon as the other extension becomes free. Your display will read CALLBACK. As soon as you pick up your receiver the other extension is rung.

If the called extension does not answer then your call will be logged in the missed callers list.

ST 25

ST 30

((D))

((D))



Notes

Please note the display messages in your System Phones, such as Call waiting, Ring back etc.

You cannot indicate call waiting to an extension

-for which Call Back when free has been set.

-whose port has been set to Answering machine, Fax, Modem, or mixed port mode.

-who has call waiting protection active

Call back -you can initiate several call backs in succession (for every extension).

You cannot initiate a callback for an extension

-for which another extension has already set call back

-who has activated Do Not Disturb (DND),

-whose port has been set to Answering machine, Fax, Modem, or mixed port mode.

-who has call waiting protection set

Callback to an extension with a Standard Phone:

-If you do not answer the call the the call back feature will be cancelled after 60 seconds.

Callback in General: Call back has been set:

-Call back will ring your extension even if Do Not Disturb has been set

-If call diversion has been set, then the Call back will not be diverted.

Power failure: All set Call Backs are cancelled.

System Telephones

Call Waiting

ST 25

ST 30

A call waiting to be answered can be signalled with the CALL WAITING TONE whilst already on a call. This tone is an audible sound indicated in your handset. This feature can be switched on or off. If this feature is set to off, then callers will hear the busy tone when your extension is in use.

Call Waiting on/off

Press SET and the CALL WAITING DENY button or Press SET 14.



Select the Primary, Secondary or both Extension Numbers as indicated in the display. The current setting is indicated.



Press ENTER or OK to make selection



Press 1 or 2 to switch on or off
Press SET to end programming



Call Waiting on/off (Feature Button)

The receiver is on the hook.
Press the Call Waiting Deny Button to switch this feature on or off



System Telephones

Call Pick Up

ST 25

ST 30

Another telephone rings with an external or an internal ringing tone. You can pick up this call on your telephone. You can also pick the call up if the answering machine has already answered it.

Call Pick Up (External)

Another telephone rings. The x in the display flashes. You wish to pick up the external call.

Lift the receiver. Press the "enter" or OK button. You are now connected to the caller.

((D))

((D))



Call Pick Up (Function Button)

You can also pick up a call by pressing the associated Feature Button, if programmed.

((D))

((D))



Call Pick Up (from Answering machine)

To Pick Up a call which has already been answered by the answering machine. Press Internal Button and dial the extension number of the Answering machine.

)

)



Notes

With a general Pick Up function button (see Function Button assignment), you can only pick up external calls from all extensions. With a special Pick Up function button (with selected extension), you can pick up external and internal calls from the defined extensions. You can program the user group by pressing SET and Pick Up Button. You cannot pick up Call Backs and Returned Calls. You can only pick up a call from an answering machine if the port has been set to answering machine.

System Telephones

Call Log

ST 25

ST 30

If a call is not answered, then the details of the caller are entered in the Call Log. Details such as Date, Time, Telephone Number and the number of times called are recorded. If the calling number matches an entry in the Phone Book, then the Phone Book entry ie the stored name is displayed instead of the number. Internal calls can enter themselves in the Call Log.

Up to a maximum of 10 entries can be made, if more entries are received then the oldest one will be deleted. A stored number will only appear once in the Call Log. If the caller rings more than once then the time of the last call is recorded in addition to the number of times called.

Entries in the Call Log are stored until the call is returned or until the entry is deleted. Calls can be returned from the Call Log by the push of a button. If a call is returned from the Call Log, then the entry will be deleted automatically from the list. The Call Log can be switched on or off separately for external and or internal calls.

Call Log on/off

Press SET 2 *

Select external or internal

The current setting is displayed.

Make selection:

ST25

0 = external

1 = on (All calls are logged)

2 = with name only (only calls which are listed in the Phone Book will be logged)

ST30

1 = off

2 = switch on (All calls are logged)

3 = with name only (only calls which are listed in the Phone Book will be logged)

Press SET to end programming

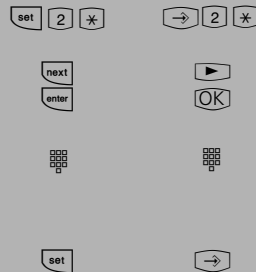

System Telephones

Display Call Log

The display of the ST25 shows "!" in addition the red LED is flashing to indicate a missed call. (ST 30 mail button is flashing, DECT 30 LED is flashing)

There will be at least one entry in the list.

To display the first entry press "enter" (or Mail Button at the ST 30) The LCD will now display the telephone number, date and time of the latest call

or
the name from the Phone Book, date and time of the latest call

or
notification to call an extension with date and time of the latest call.

Further entries can be displayed by pressing the NEXT button. The LED continues flashing until all entries have been displayed after which the LED will stay illuminated until calls are returned or deleted.

On lifting the receiver you will be connected to the number displayed in the LCD. The entry will be removed from the list if the call is answered or remain there if no answer is received. To delete an entry display the number and press CLEAR.

ST 25

ST 30



Browse



Dial



Delete



Notes

The Call Log Display is cancelled when pressing "esc".

The Call Log will display numbers with the STD Code.

It may not be possible to return a call from the Call Log if your extension is call barred.

The Call Log will not be stored in the event of a power failure.

System Telephones

Do Not Disturb (Setting on/ off)

ST 25

ST 30

You can set Do Not Disturb for the first or second internal number of your extension and also for internal and or external calls. If an extension is ringing you while this feature is set then busy tone will be returned. External calls will not ring your phone.

Do Not Disturb (on)

With the receiver on hook. Press the DO NOT DISTURB Button. The red LED will light up and the LCD will display for 20 seconds the following message: DO NOT DISTURB ON.



Do Not Disturb (off)

With the receiver on hook. Press the DO NOT DISTURB Button. The red LED will go off and the LCD will display for 20 seconds the following message: DO NOT DISTURB OFF



Programming the Do Not Disturb function

PRESS Set 12

The LCD will display if a first and second number have been allocated to your extension.

(Primary & Secondary Number)

"1": Do Not Disturb for first internal number and/or

"2": Do Not Disturb for second internal number. Example: "1" and "2"

Press "enter" to confirm. Select if Do Not Disturb is to apply to internal and/or external calls.

"1": Do Not Disturb for internal calls and/or

"2": Do Not Disturb for external calls

Example: "1" Do Not Disturb for internal calls only

Press SET to activate the feature.

This feature can now be activated for the selection made in this program at the push of a button. ie press the Do Not Disturb Button to toggle between on or off.



System Telephones

Notes

ST 25

ST 30

If Do Not Disturb is activated:

-
- External Calls are indicated in the Display only but can be picked up.
- You can still make calls. When you pick up the receiver, the special dial tone will remind you that Do Not Disturb is set to on.
- Your telephone will still ring for callback, wake up - and appointment calls.

You can program several special DO NOT DISTURB function Buttons. You can program a , DO NOT DISTURB function button for your first, second or both first and second internal numbers. In addition you can set this function for internal, external or all calls. (See allocation of function buttons)

Switching between Day and Night Service

Which extension should ring on an incoming call is set in the 'Call Variant' under Day/ Night Service. If several extensions ring on an incoming call then the one who picks up the receiver first will have answered the call.

An incoming call can ring different extensions depending if the system is running under Day or Night Service.

Night Service can be set for each incoming line separately.

Day - Night Service can be activated from any extension on the system or remotely. Please refer to the operating instruction for an analogue phone on how to switch Day- Night Service from an external phone.

Night Service on/ off

Press SET and press the Night Service Button or Press SET 11 to switch to Night Service.

Press NEXT to select the line or name to which Night Service should apply. Press ALL if you want to activate Night Service for all incoming lines.

Select on or off.

Press SET to end programming

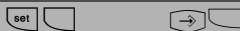

System Telephones

Night Service on/ off via Special Function Button

ST 25

ST 30

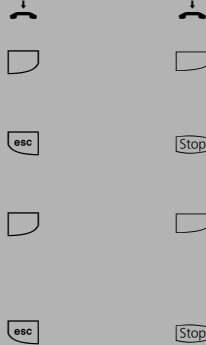

If a function button and line has been assigned permanently to your extension, then you can switch this line to Night Service by simply pressing the "AVA 2" (Night Button)

With the receiver on the hook. Press the "AVA 2"(Night)Button. Night Service is now active for this line. Press this Button again to go back to Day Service. To remind you of this setting a Half Moon Symbol and the "!" is displayed on your phone. To switch to Day Service press the Night Button again and the Night Service Symbol and "!" will extinguish. Your line is now back in Day Service.



Notes

The "!" may be displayed for more than one setting of your system. The settings can be displayed on continued pressing of .

 will indicate for which line the service is active. The displayed setting can be switched off with . If Night Service has been set up for all lines then switching this service on or off will also cause the Doorphone to be switched to the same setting.

System Telephones

Call Forwarding (on/off) with Special Function Button

ST 25

ST 30

If a telephone number has been permanently assigned to your extension on Set Up of the AVA 3 function button, (Call Forward) then you can switch this feature on or off at the push of a button.

With the receiver on hook.
Press the "AVA 3" (Call Forward Button)
Call Forward is now active and will be indicated with the "!" in the display of your phone.

This button has a toggle function which means if you press it again Call Forward will be switched off and the "!" is now not displayed.



System Telephones

Call Deflection

Forwarding a call during the ringing phase

ST 25

ST 30

Providing this feature is available from your network provider you can forward an incoming call to another extension or outside number whilst ringing. This is useful if you do not wish to answer a particular call.

Call Deflection

An incoming call arrives and the number is displayed on your phone.

Press the "CALL DEFLECTION BUTTON"
You can forward the call to an extension or an outside number.



Dial the number you wish to forward the call to.



Press "ENTER" the call is now forwarded.
You can choose a number from your Phonebook or Speed Dial Button.



Reject a call during the ringing phase

Once your phone rings, press the REJECT Button. Your phone stops ringing, if you are the only phone programmed to ring then the caller will get busy tone returned. If other phones are programmed to ring then the caller continues to hear ringing tone.



Call Forwarding for an extension on a system connection (PTP)

With this feature incoming calls of an extension are diverted during the ringing phase. (Partial Rerouting). Providing that this feature is available from the network provider and that the checkbox is ticked in the program section SO Bus settings. Calls are diverted via the public exchange without engaging the second B Channel.

System Telephones

Announcement

ST 25

ST 30

You can make an announcement via the telephone system either via a connected PA System (AS3X only) or through system telephones.

Announcement (Paging)

With the receiver on hook.
Press the ANNOUNCEMENT Button.
An acknowledgement tone sounds.
Make your announcement either in the handsfree mode or by using the handset. Replace the handset or press the Speaker Button to end announcement.

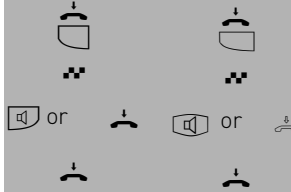

Auto Dialling (Hotline)

With this feature a pre-set number is dialled within 10 seconds after lifting the receiver. Calls can still be made normally providing dialling commences within 10 seconds.

Storing a Number for Auto Dialling

Press SET 56



Enter the external phone number



Press SET to end programming



Notes

Please check your setting after having programmed this feature. Lift the receiver and wait till the programmed number is dialled. Check that you are connected to the correct number.

System Telephones

Switch Auto Dialling on/ off

Press SET 1 *

Press 1 for off
or
Press 2 for on

Press SET to end programming

ST 25



ST 30

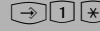

Notes

If the called party is busy, the telephone system attempts to redial the external phone number every 10 seconds. It cancels automatic dialling after 12 attempts.

The Auto Dial function has preference above all other connections. This means should all lines be busy then the Auto Dial feature will force release a line in order to establish a connection.

If you hear the error tone when activating AUTO DIALLING, then no external phone number has been programmed.

Busy on Busy

This feature is used in the following situation. If an incoming line is programmed to ring several phones, then each time a new call arrives the free extensions within the group will ring. If, however, for some reason you are the only one in the office and are already on a call then the next incoming call would cause the free extensions to ring. It may not be possible to answer the new call in time and therefore the caller may get the impression that no one is in the office. If Busy on Busy is set on the other hand than any extension within the ringing group who is on a call will cause for a new caller to hear busy tone. Note: This will not place restrictions on outgoing calls.

Busy on Busy - Programming and Switching

Press SET and Press the BUSY on BUSY Button
or Press SET 1 #
Select the line or name

"1": Busy on busy on
"0": Busy on busy off

Press NEXT to select another number
or
Press SET to end programming



System Telephones

Busy on Busy on/off

ST 25

ST 30

The receiver is on hook. By pressing the BUSY ON BUSY Button you switch this feature on or off.



Notes

An ISDN terminal that is connected in parallel to the telephone system on a point-to-multipoint line and to which the same number as the system has been assigned will always ring, regardless if BUSY ON BUSY is active or not.

Voice Message Announcement

You can use your telephone system like an intercom, i.e. you can make a voice message announcement to other system telephones connected to the system in the form of a:

- Announcement to one, a group or all system telephones
- Announcement to a defined group of system telephones (see "Group formation").

The speakers of the system telephones receiving the announcement are automatically switched on, unless they are busy on another call.

You can also make a voice message announcement out of an external call.

A voice message is only possible if you have programmed a function button as VOICE MESSAGE (Announcement) see also function button assignment.

Voice Message to System Phones

With the receiver on hook.
Press the ANNOUNCEMENT BUTTON
You now can select an extension number or a group number. If no number is selected all system phones will receive your announcement.
Press the ENTER button and make your announcement either using the receiver or in handsfree mode.
If at least one of the system phones is free to receive your announcement then you and the recipient will hear the acknowledgement tone.
If an extension picks up the receiver during an announcement then you will be connected to this extension and the announcement mode will be cleared.
After your announcement, replace the receiver or press the SPEAKER button.



or



or



System Telephones

Voice Message to a Group

With the receiver on hook.

Press the VOICE MESSAGE Button.

If at least one of the system telephones belonging to the group is free, you and the voice message participants hear the acknowledgement tone. You can make your voice announcement in the hands free mode or you can use the receiver.

If an extension picks up the receiver during an announcement then you will be connected to this extension and the announcement mode will be cleared. After your announcement, replace the receiver or press the SPEAKER button.

ST 25



ST 30



Voice Message out of an External Call

Whilst on an outside call you can page a person using the Voice Message Announcement feature.

During the call press the VOICE MESSAGE Button. Dial the extension, group or none for all.

Press ENTER If at least one system phone is free to receive your announcement, then you and the recipient(s) hear an acknowledgement tone. Make your announcement.

If the paged persons picks up the receiver then he will be connected to your extension and the Voice Announcement Mode is cleared.

Replace the receiver if you want to transfer the call.

You can also replace the receiver before the other extension has picked up the handset. Just replace your receiver after your announcement. The call will be placed on hold for all extensions within the group.

As soon as any extension within the group picks up the receiver the call is connected. The call will be returned to you if it remained unanswered within 4 minutes.



System Telephones

On Hearing an Announcement

ST 25

ST 30

On hearing the announcement

Press the SPEAKER Button or lift the receiver. You will be automatically connected to the announcing extension. If you are the only extension to which this announcement is directed and providing your phone is programmed for automatic microphone activation, then you can speak to the announcing extension without the need to pick up the receiver or pressing the speaker button. To end the call press the speaker button or replace the receiver.



Note

An announcement can only be made to system phones. At least one of the system phones must be free. If an announcement is directed to a single extension who has automatic microphone activation enabled, then this extension can speak direct to the announcing extension without the need to press the speaker button or to lift the receiver. The speaker volume can be adjusted by altering the handfree volume setting. You can store an extension number or group number by pressing SET and the ANNOUNCEMENT button. To clear the entry press SET and the ANNOUNCEMENT button and press clear.

System Telephones

To place a Call on Hold

ST 25

ST 30

You can put a call on hold in order to make an enquiry call via the ISDN exchange, however this is only possible if your line is a Point-To-Multipoint connection. Note: This feature may not be available from your network provider. (not available from network providers in the UK) This feature would allow to make an enquiry call to another outside number even though no line (B Channel) is available. The call is put on hold in the exchange therefore releasing a line to be used to set up another call. You then can alternate between the calls by using the SPLIT button.

Place a Call on Hold (may not be available from network provider)

You are on an outside call (Point-to-Multipoint only) Press the ISDN HOLD Button
You hear external dial tone

Dial the required telephone number
The display on your phone will show the current call connected to

Press the ESC button if the other party does not answer and you want to return to your original call

OR

Press the ISDN HOLD Button to switch between calls.

On pressing the ESC Button you will clear the current call and be returned to the other call.



Note

A call cannot be placed on hold in the exchange if you hear the error tone. You are connected back to the other call by pressing the ESC button.

When you replace your receiver, you will clear both calls, the current and the holding one. Call charges are incurred for the current call and for the one on hold.

System Telephones

Remote Dial Functions

ST 25

ST 30

With this feature it is possible to dial a number on behalf of another extension. (i. e. the Secretary for the Manager) This feature must be enabled on the extension for which calls can be made. At the time system phones only can set up calls for other extensions.

The following options are available:

- Remote Dial all (every extension can set up a call for you)
- Remote Dial off
- Remote Dial allowed from extension/group
- Remote Dial allowed via CTI
- Remote Dial switches system telephone to handsfree and dials number (system phones only).

Remote Dialling

With the handset on hook.
Select the Remote Dial Menu

with NEXT select the remote dial required
(off, Extn number, all external)
Press ENTER
Activate selection by pressing ENTER

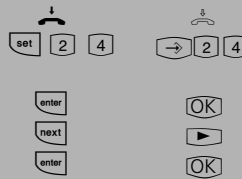

CTI Dialling

With the handset on hook.

Select the Remote Dial Menu
Select the item CTI dialling.

Select the desired setting and activate with **OK**.

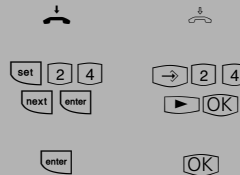

Automatic Call and Automatic Mike

Please proceed exactly as for CTI dialling for the items Automatic Call & Automatic Mike.

System Telephones

Malicious Call Identification (MCID)

ST 25

ST 30

This feature will have to be supplied by your network provider.
The ISDN exchange will store the callers number and the date and time of the call.
This trace can be activated during the call or after the caller has hung up but must be activated before you terminate the call.

Tracing a Call

Nuisance or Malicious calls can be traced

On receiving such call

Press the CALL TRACING Button
You will hear an acknowledgement tone from the exchange.
Replace the receiver.



Note

Press the ESC button if you want to continue the call after the trace has been activated.
Until you return to the caller he will hear Music on Hold if applicable.
You hear the error tone if:
-Malicious Call Identification has not been made available by your network operator
OR
-when the caller could not be identified by the telephone exchange.

System Telephones

Conference

ST 25

ST 30

Three Party Conference via your Phone System

You can hold a three party conference with analogue or digital extensions of the system.

Or with one external call and one extension

Or with two external calls. Note you will use 2 lines (B Channels)

Three Party Conference via the ISDN Telephone Exchange (PTMP lines only)

Note this service is a feature of the Telephone Exchange and may not be available.

To establish a three party conference via the exchange you must first establish the call with the first party. Then hold the call in the exchange to establish an enquiry call on the same line to the second party after which you will switch to a three party conference.

Three Party Conference (with two other extensions)

Establish a call to an extension during the call

Press the INTERNAL Button or the R (Recall) Button

Dial the second extension number

During this call press the CONFERENCE Button

All extensions will hear the confirmation tone and the conference call is established.

You can split an existing conference call by pressing the SPLIT Button and talk to each extension in turn.



System Telephones

Internal - External Three Party Conference

ST 25

ST 30

Whilst on an external call
Press the SPLIT Button
Dial the required telephone number
Press the conference button once the called party has answered. You hear the acknowledgement tone, the three party conference call is established.



To split the conference press the SPLIT button and talk to each line in turn. If you press TRANSFER whilst the call is in this condition you will connect the two parties whilst you will be disconnected.



ISDN Three Party Conference

(Only applicable to PTMP lines)



Whilst on a call press the ISDN Hold button



You hear external dial tone.
Dial the new number required.



Your first caller is put on hold and cannot overhear the conversation.



If the new call is answered press the CONFERENCE button
your Three Party Conference has been established.



If the new called number fails to answer, then press ESC you will now be connected to the original call. Your Three Party Conference will be cleared once you replace your receiver.



Notes

Three Party Conference via the Telephone System.

An incoming – or doorphone call will be signalled to the conference with the call waiting tone if the called extension is part of the conference.

The Pick Up of a call is only possible by the extension who established the conference (Conference Manager) by pressing the SPLIT button and selecting the call with the next button. The other members of the conference are put on hold until the conference manager has finished the enquiry call by pressing the ESC button after which he can re-establish the conference with the SPLIT and the CONFERENCE button. If an extension replaces the receiver then that extension is disconnected from the conference and can only be re invited via the conference manager. The conference is cancelled as soon as the conference manager replaces his receiver.

Conference circuit via the ISDN exchange

Call charges are incurred for every participant of the conference. If you hear an error tone instead of an exchange dial tone, then the holding of a call in the exchange is not possible. Press the ESC button to return to the original call. The Three Party Conference is not possible if you hear the error tone after pressing the CONFERENCE button. Press the ESC button to reconnect to the original call. Press the CONFERENCE button if you wish to clear an established ISDN Three Party Conference. You are connected to the party that you last invited into the conference .The first called party is put on hold.

System Telephones

Least Cost Routing (LCR)

ST 25

ST 30

This feature will make use of various network providers offering cheap call rates. Calls are routed depending on the STD Code dialled which is also dependent on the time and day of the week. If it is not possible to connect to the relevant provider after a preset number of attempts then the system will try to route the call via a preset alternative provider. (Fallback)

The access code of the relevant provider will be prefixed by the system to the number dialled.

The Least Cost Routing can cater for up to 8 network providers in 8 time slots depending on time of day and day of week. Least Cost Routing can be programmed with TK-LCR on your PC. Least Cost Routing can be switched on or off on your extension.

Switching Least Cost Routing on/off

Press the LCR function button to switch this feature on or off for your extension.



Notes

You can still select which network provider is used for your call despite LCR being enabled.

- Simply prefix your number with the network access code
- You can also select the network provider with the function button CALL BY CALL on a system phone. (see also Network access code -Call by Call).

The network access code for the network operator is only stored in the last number redial memory if this has been dialled manually before.

Important! Not all ISDN features described may be available. Please check with your network provider for availability.

System Telephones

Call Split (Brokers Call) switching between calls

ST 25

ST 30

Brokers Call is a feature whereby you can talk to one internal and one external call in turn without connecting them. Call Split is the same feature but it is possible to do this between external calls. The waiting caller will hear Music on Hold if applicable.

Call Split

Whilst on a call the callers details are displayed in the LCD if another call arrives then this will be indicated by the call waiting tone and the new callers details are displayed in the LCD. If you want to answer the new call and put the current one on hold press the SPLIT button. The active call is displayed in the first line and the waiting or call on hold is displayed in the second line of the LCD. Should another call arrive then again as before the new callers details are displayed in the first line of the LCD. By pressing the SPLIT button you are connected to the new caller. Pressing the SPLIT button in succession will connect you to each waiting caller in turn.

Display calls on hold during a conversation

(Not available for all Countries)

Browse with the NEXT button

1st line LCD Number / Name or External

2nd line LCD Number / or Name of line

H: Call on Hold

R: New Incoming Call

V: Connected or active Call

To switch to call displayed

Press SPLIT



Notes

Some function buttons of the system phones may refer to the above described feature as Brokers Call.

Call charges will be incurred for all outgoing calls even whilst on hold. To end a current call, press the "esc" key. You are automatically connected to the next call waiting.

If you replace the receiver:

-you clear all extension calls,

-you clear the current external call,

-you receive a callback if an external call is still on hold.

System Telephones

Storing the Last Number (incoming or outgoing)

ST 25

ST 30

The last five numbers incoming or outgoing will be stored in your phone. Any of these five numbers can be called back or transferred to your own personal phone memory. Note in order to perform this function you must have a button programmed on your phone called 'Clipboard' to recall the numbers and a button 'Dest. Private' to store the number into.

Displaying and Calling a number

Press the button CLIPBOARD the first number will be displayed. Continue to press CLIPBOARD or NEXT until the desired number is displayed. Lift the receiver the number displayed will now be dialed.

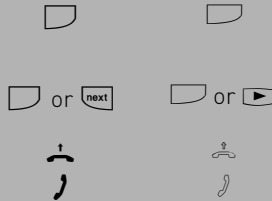

Display and Store in Phone Memory

Press SET + DEST. PRIVATE button
A previously stored number if applicable will now be displayed.

Press the CLIPBOARD button until the desired number is displayed

Press the DEST.PRIVATE button followed by the ENTER or OK button
enter a name if required press ENTER or OK

Press SET to leave programming

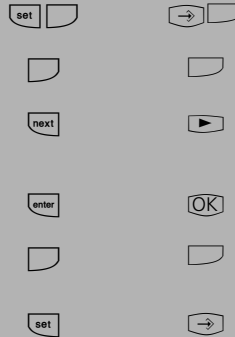

System Telephones

Carrier Access Code – on a Call by Call basis

ST 25

ST 30

You can select an alternative network provider on a Call by Call basis with an assigned function button. Press the function button to select a provider and dial the required telephone number. You can call numbers from your own memory, central dialling (Phone Book) or last number redial. To use this feature you must have a network provider stored in the feature button called CALL BY CALL. You can select a network provider from the LCR table to assign this to the CALL BY CALL button.

Storing the network provider for the 'Call by Call' Button

Start programming by pressing SET followed by the CALL BY CALL function button. (for second level press shift first)

A already stored provider will be displayed press NEXT to select another provider.

Press SET to confirm selection and end programming.

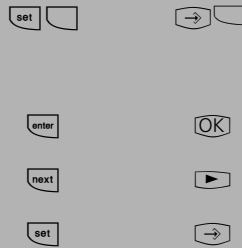

Dialling with Call by Call Button

Lift the receiver and press the "Call by Call" button. The stored network access code is displayed and dialled.

Dial the required telephone number (STD + Number)

or select the number by pressing a Speed Dial Button or Last Number Redial.

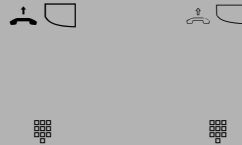

Notes

The network access code which has been dialled with the Call By Call button will not be stored in the last number redial.

System Telephones

Parking a Call

ST 25

ST 30

You can park an external call in the system and retrieve this from another extension. The parked call will engage the line (B Channel). The parked caller will hear Music on hold (if enabled). Calls parked will recall your extension within 4 minutes if it has not been retrieved.

Calls can also be parked or retrieved with an index number. This feature is useful if several calls are parked at any time.

This function can be activated in the configuration section 'other functions' or via a program entry on the phone.

Parking / Retrieving a Call

If you would like to park your call press ENTER or OK.



Replace your handset. x will flash in the display.



To retrieve the call



Pick up the handset and press ENTER or OK, the call is reconnected,



Parking/ / Retrieving a Call with Index Number

If you would like to park your call press ENTER or OK followed by a 2 digit index number from 00 to 99. Replace your handset, x will flash i the display.



To retrieve the call
Pick up the handset
and press ENTER or OK followed by the
2 digit index number, the call is
reconnected.



System Telephones

Notes

ST 25

ST 30

You can retrieve a parked call from any telephone.

On the standard phone dial *22 to retrieve a parked call. If several calls are parked then the first one will be returned. Outgoing call incur charges when parked.

Baby Listening / Room Monitor

Any phone can be used for this feature (system- or standard phone) The phone set to Room Monitor (Baby Listening can be called from any telephone either internal or external. A system phone when called will switch on the microphone automatically. This feature must be enabled for the phone intended to be used as as monitor. You can select whether or not a warning tone sounds when listening into a room. The monitor phone can be called from any phone either internal or external. Please refer to the instruction manual chapter 'Room monitoring from an analogue phone' on how to access this feature from an external phone.

Set Up Room Monitor

Press SET 10 to set up the room monitor extension. The current setting is displayed.

"1": Room monitor on

"0": Room monitor off

Press "ENTER" to confirm.

Select whether or not a tone should sound before the room monitor feature is activated.

"1": Audible warning on

"0": Audible warning off

The green LED flashes when room monitoring is active.

Press SET to leave programming

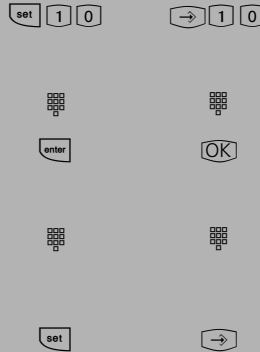

Calling the Room Monitor Extension

Pick up the receiver

Dial the required monitor extension

Listen into the room.

Please note that you can also be heard when listening into a room.

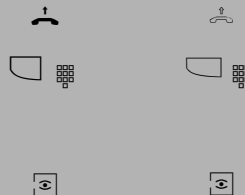

System Telephones

Switching Relays

ST 25

ST 30

The telephone system has two potential free relays R1 and R2 which can be switched remotely. You could activate a bell or another door opener.
If no door phone TFE 1 (FTZ 123 D12) is connected to the telephone system then the relay contacts T0 (relay R3) and TS (relay R4) can also be used for other functions.

Relay on/off

Press the RELAY button to turn a relay on/off.

Select a relay with NEXT

"1": Selected relay on

"0": Selected relay off

Return to the standard display by pressing the "esc".



Relay on/off with Special Function Button

Turn the relay on or off with the "RELAY" button. If the relay is a pulse relay, then the second line of the display remains unchanged.

The displayed message will disappear after a few seconds or return immediately by pressing "ESC".



System Telephones

Enquiry

ST 25

ST 30

You can place your current call on hold, while you talk to an extension or another external call. The caller on hold will hear Music on Hold and can not overhear your conversation. Whilst on an enquiry call you can use all functions such as telephone book, paging etc.

Telephone Enquiry

Whilst having a telephone conversation

Internal Enquiry

Press the internal button or press the R button and dial the internal phone number

External Enquiry

Press the SPLIT or BROKERS CALL button and dial an external telephone number. Whilst talking to the new call the call on hold cannot hear your conversation. To return to the waiting call: Press the ESC button the enquiry call is cleared or if you press the SPLIT (Brokers Call) button the enquiry call is put on hold.



Enquiry (Mute)

To talk to another person in the room without the caller being able to hear:

(internal or external calls)

Press the R or the internal button. Your current call is put on hold. You now can talk to someone in the room without the caller hearing this.

To return to the caller on the phone press the R or ESC button.

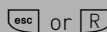
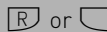

System Telephones

Automatic Call Back

ST 25

ST 30

You can set up an automatic call back if the number you are calling is busy. This feature is only available to subscribers of ISDN lines. Your phone will ring as soon as the called party replaces the receiver. The other party will be called automatically as soon as you pick up your receiver.

Set Up Call Back

On hearing the busy tone



press ENTER, Call Back has now been initiated. Replace your receiver.



Receiving a Call Back

Your telephone rings as soon as the other party is free again. The display shows the callback.



Lift the receiver. The other party is automatically called back.



Should the called number fail to answer then you details will be entered in the Call Log



as soon as you replace your receiver.



Notes

If your display reads:

```
Number busy  
replace receiver
```

then it will not be possible to be called back from the busy number. The feature Call Back on busy is not available from the telephone exchange. The feature will be cancelled if you do not answer the returned call within 20 seconds.

Call Back will be cancelled if the Call Back feature is completed or failed to connect the call after 45 minutes.

System Telephones

Viewing Extension Status

ST 25

ST 30

It may also be possible that several functions are active, this will be indicated by the red flashing LED and the '!'.
You can view the status and or messages in order of succession.

Scrolling through Display Messages

The receiver is on hook. You will see the the symbol '!' to indicate an entry. The date will be displayed.
Call Log will be displayed. There is at least one entry in the Call Log.



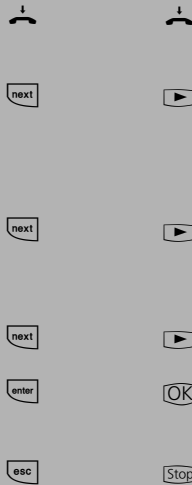

To see further entries press next, if applicable you will see the next entry.
Browse by pressing the next button.
Phone settings such as 'Diversion' may be indicated.

Press enter to read. Display will return to default after 20 seconds.

Press ESC to return to default immediately.





Notes

By pressing  , you can view the display in succession. You also can display the telephone number to which setting applies by pressing . If applicable, you can press  to read out the phone number to which the setting applies. Should you receive a call during the display of features, then the callers number will be displayed and your phone can be operated as usual.

Pop Up Menu (Status Display)

Please take note of the telephones display which will guide you through all function settings. If status display is enabled (Default Setting) then the following call handling functions will be offered in the 4th line of the display.

Answer, Park Call, Retrieve, Pick Up, Call Split, Transfer, Call Back, Conference, Enquiry, Reject, Disconnect, Call Deflect to, Back, End, Door opener.

The system will offer the most common function, but others may be displayed by using the arrow buttons  . The displayed function will be carried out once the OK button is pressed.

System Telephones

Switch Pop Up Menu on/off

Enter programming mode.
Select desired function with NEXT and confirm with OK .
Press SET to end programming.
On the DECT 30 the Pop Up menu is always set to on.

ST 25

ST 30

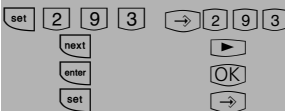

Set Extension Names

You can set a name for your telephone extension. Your name will then appears in the display of other system phones you are calling.

Enter programming mode.

Enter name with the dial keypad (see notes). Confirm entry by pressing ENTER.

End programming by pressing SET.

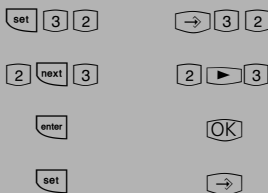

Notes

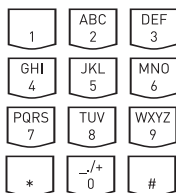

Enter a name on the keypad:
If necessary,press several times Example:
2 =A
22 =B
222 =C
Press NEXT to enter the next field or wait for the cursor to move over automatically.
Previous character can be overwritten.

Flashing character can be deleted, or delete complete entry.

With [↕] change to upper or lower case. ie ABC or abc.

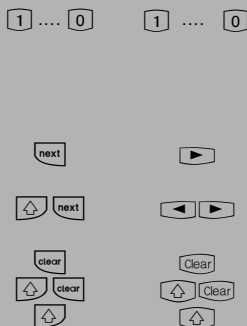



System Telephones

Storing Phonebook Numbers (Central Dialling Memory)

ST 25

ST 30

Up to 1000 telephone numbers and names can be stored in the central dialling memory. The numbers can be recalled by pressing the Phonebook button available on every system phone. Entries can be retrieved alphabetically. To change between retrieval method, press the  and  button. You can also store program functions and use the * and (R)ecall buttons. With this method all features could be used from telephones who do not support or have the * and R button. Single button memory (Emergency) dialling is reserved for the * and # buttons. You can centrally store up to 1000 important external phone numbers and affiliated names in the telephone system. These telephone numbers can then be selected from every system telephone by pressing the "phonebook" button, either via a numeric or an alphabetical register.

Storing a Number

Press the SET and PHONEBOOK button to access this programming area or go directly to the next available entry by pressing SET 51. The next free memory location is displayed. Enter the number you wish to store

Enter the name, i. e. AD
(2 = A, next, 3 = D; see notes under "Entering Extension Names")
Confirm
ENTER: store a further phone number or SET to end programming

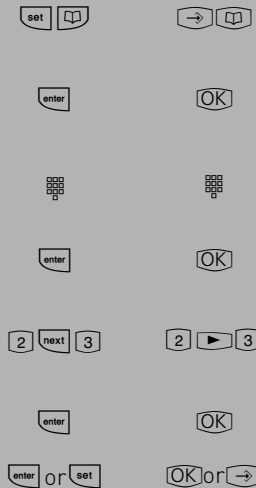

Notes

When storing a number do not use the line access digit. The outside line is automatically seized when a number is dialled from the Phonebook. Dialled numbers from the Phonebook can be added too from your phone if additional digits will be dialled within 20 seconds. Users may dial from the Phonebook regardless if they are call barred or not. Stored emergency and Babysitter numbers can always be dialled even if the preset cost limit has been reached.

System Telephones

Changing a Number in the Phonebook

Press the SET and PHONEBOOK button to access this programming area or go directly to the input section by pressing SET 52.

Select the program item by pressing NEXT

Confirm the selection

Enter the location of the stored number (between 000 and 999), ie. 005

Confirm

Clear individual digits of the phone number by pressing the clear button or clear all by pressing the SHIFT and CLEAR button.

Edit the number

Confirm

Confirm or clear and modify the displayed name

ENTER to change a further number in the phonebook or

Press SET to end programming

ST 25



ST 30

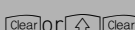

Notes

If "no entry" is displayed after a number has been entered, then by pressing * will go backwards from 999 and □ will go forward from 000.

System Telephones

Deleting a Number from the phonebook

Press SET and the PHONEBOOK button to access this program area or go directly to the input section by pressing SET 53

Select the program item with NEXT

Confirm the selection

Enter the location of the stored number (between 000 and 999), ie. 005

Confirm the entered abbreviated dialling number.

Confirm deletion by pressing ENTER or cancel the operation by pressing ESC.

ENTER: to clear a further number or SET to end programming

ST 25

ST 30

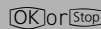

Entering an Emergency Number

Press SET and the PHONEBOOK button to access this program area or go directly to the input section by pressing SET 54

Select the program item with NEXT

Select the program item by pressing "next"

Confirm the selection

Select the emergency button for example *

Enter the emergency phone number

Press ENTER: to enter another emergency number ie # or press SET to end programming

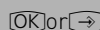

System Telephones

Store a Direct Call Number

Press SET and the PHONEBOOK button to access this program area or go directly to the input section by pressing SET 55
Select the program item with NEXT

Confirm the selection

Enter the phone number you wish to store

Press SET to end programming

ST 25



ST 30



Notes

To delete a single characters press or clear all by pressing .

Lock your phone to activate this feature. Press the feature button if programmed or dial SET 13. Once your phone is locked you can only access the direct call or emergency numbers.

Dialling Numbers from the Phone Book

Numbers in the Phone Book can be retrieved alphabetical, numerical or as vanity dial.

Vanity dialling: With the Vanity dialling you do not have to remember the location of the speed dial number in the phone book. Just enter the name . The name will be displayed as soon as a match has been found.

Example:

Select entries in the phone book with

Dellmann



Diener



Edner

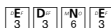

Fenlo

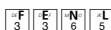

System Telephones

Changing the retrieval method

With the handset on hook.

Select retrieval method
Select the desired dialling menu (Vanity, numerical, alphabetical) and confirm selection

ST 25

ST 30



Phonebook (Numeric retrieval)

With the receiver on hook.

Initiate abbreviated dialling by pressing the Phonebook button. Enter the stored location of the entry, ie 000 to 999. The number will be displayed. You can scroll back and forth using the * and # buttons.

Lift the receiver or press the handsfree button. The displayed number will be dialled.



or



or



System Telephones

Phonebook (Alphabetic retrieval)

With the receiver on hook. Initiate abbreviated dialling by press the Phonebook button.

Press the NEXT button to move to the input for the second letter. The input cursor flashes

Enter the second letter, i. e. N =66. You can scroll up and down by pressing * and # respectively.

Lift the receiver or press the handsfree button. The displayed phone number will be dialled automatically.

ST 25

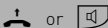

ST 30

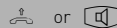

Phonebook (Vanity retrieval)

With the handset on hook.

Enter the desired letter, i.e. A =2. The first entry with the selected initial letter is displayed.

Select the next letter, i.e. N =6. The first entry with "An " is displayed.

Lift the receiver or press the handsfree button, the displayed name will automatically be dialled.

Press the * button to go back to the previous letter.

You can switch the LCD to display the telephone number by pressing the # button.

You can scroll with the NEXT button.

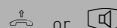
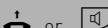

System Telephones

Redial a Number from the Phonebook

With the receiver on hook.

Initiate abbreviated dialling by pressing the Phonebook button. You are in the last used method of retrieval (numeric or alphabetical).

If necessary, press the "shift" button to switch to the another method of retrieval. Press the REDIAL button. The entry that was last displayed or dialled will be shown.

Lift the receiver or press the handsfree button you will be connected to the displayed number.

ST 25



ST 30

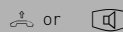

Notes

You can set in the configuration of the system, if extensions which have no line access can dial numbers from the phonebook.

If your extension is barred, then you cannot dial numbers from the phonebook which fall into this category. You will hear error tone.

The phonebook will always be displayed in the last used method of retrieval (numeric or alphanumeric)

If a number has been stored without a name in the phone book, then the only method of retrieval will be numeric.

Abbreviated numbers can also be dialled if the telephone receiver is off hook, for example when on an enquiry call. In this case you have to select the required number by pressing the button ENTER.

Incomplete telephone numbers can be added too: Select abbreviated number, pick up handset or press handsfree button, then add required digits to telephone number.

System Telephones

Telephone Lock - Emergency/Direct Call (Baby Call)

ST 25

ST 30

You can protect your telephone against unauthorised use by locking it.

If your telephone is locked,you can:

-only call extensions

-accept all incoming calls and transfer them to extensions

-only call the stored emergency and direct call phone number.

In addition you can use automatic dialling (Hotline) but this feature must have been enabled before locking your phone. If you have programmed a PIN number for your phone, then this must be entered to either lock or unlock your phone.

Locking your Phone (with Function Button)

With the receiver on hook.Press the "Telephone lock "button.(if programmed) The telephone is locked. If a PIN number is prompted then this must be entered before the phone can be locked. Error tone will be returned in an attempt to dial a number whilst the phone is locked.

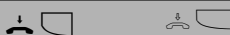

Unlocking your Phone (with Function Button)

With the receiver on hook.Press the "Telephone lock "button.The telephone is unlocked. If a PIN number is prompted then this must be entered first before the phone can be unlocked.



Locking your Phone (without Function Button)

Press SET 13.

Enter the PIN number if prompted. The current setting is displayed.

"1 ": to lock phone

Press the SET button

This will end the lock procedure.

Your telephone is locked.

The display shows "Telephone lock "or, Emergency/ Baby call if this has been stored. Error tone will be returned for anyone trying to make an outside call.



1

1

set

→

System Telephones

Unlocking your Phone (without a Function button)

Press SET 13.
Enter your PIN if prompted.
The current setting is displayed

"0 ":Unlock the telephone

Press the "set " button.
This will end the unlocking procedure.

ST 25

ST 30



Emergency Call

The telephone is locked and the receiver is on hook.

Emergency call *or # only.Example: "*".The phone number is displayed.
Lift the receiver.The phone number is dialled automatically
or

press the handsfree button to dial the displayed number.



Direct Call (Baby Call)

The telephone is locked.
Lift the receiver.
When any button is pressed, the phone number stored as the direct number is dialled.



Notes

The emergency call/direct call function has priority over all outside connections in progress. If necessary a call in progress will be force released in order that the emergency call can be set up.

System Telephones

Appointment Call (Non-Recurring)

ST 25

ST 30

Your telephone can remind you of an appointment. At a set date and time your phone will ring to remind you. This function can be switched on or off at any time. An appointment call will ring even if your phone has been set to DO NOT DISTURB.

Set Up an Appointment Call

Press the SET and APPOINTMENT button or Press SET 15



Enter the time in the 24 hour format HHMM press the ENTER button. Today's date is shown.



Enter new date if required or press ENTER to accept. Press the SET button to store the entered details and to automatically activate the appointment call. The Clock symbol and or exclamation mark will be displayed as a reminder that this function is set.



Appointment Call (switch off)

Press the APPOINTMENT button. The stored appointment time appears in the top line of the display. The appointment call is now switched off. Press the "esc" button to return to the standard display. The clock symbol and the exclamation mark "!" are now switched off.



Appointment Call (switch on)

Press the APPOINTMENT button. The stored appointment time appears in the top line of the display. The appointment call is now switched on. Press the "esc" button to return to the standard display. The clock symbol and the exclamation mark "!" are now visible in the display.



System Telephones

Receiving an Appointment Call

ST 25

ST 30

The appointment call rings at the set time. Your display shows the "Appointment call" message for 20 seconds. The red LED flashes.

The flashing clock symbol and the flashing red LED reminds you of the passed appointment. As long as "Appointment call" is displayed, you can switch it off by pressing the button "esc". At any other time you must press the button APPOINTMENT for this feature to be switched off.

A small rectangular button icon with the text "esc" inside.A small rectangular button icon with the text "Stop" inside.

Notes

You are only reminded of an appointment if this has been switched on. To stop further appointment calls, switch this feature off. You can switch a stored appointment on or off with the APPOINTMENT button. (Toggle switch)

If you are on the phone while your appointment call tries to ring you then the message, Appointment Call' will be displayed for 20 seconds with the red LED flashing. After you have replaced your receiver the Clock Symbol and red LED will continue to flash to remind you of the expired appointment. Switch off appointment call by pressing the associated button.

An appointment call will only ring your phone even if a diversion has been set.

System Telephones

Timer functions

ST 25

ST 30

The telephone system has timers that can be used to activate certain functions at specific times. The following features can be time controlled:

- AIS announcement text
- Busy-on-busy
- Call barring
- Call Distributiun by Day / Night
- Call Distributiun Door
- Call Distributiun Forwarding
- Diversion
- Do not disturb
- Hunt group mode
- Phone lock
- Phonebook Macro
- TAM

You can assign one or more functions to any timer. Up to 10 functions can be switched by timers. The timers can only be programmed in the "TK-Suite" program.

Timers can be switched on or off manually from any phone for example the Office closes early and therefore night service needs to be switched on prior to the set time.

Several timers can be grouped into one so that they can be activated simultaneously.

Activating/deactivating Timers

Press the "Timer" button to enable the timer for the preset feature.

"1": The timer is active. The function(s) will be switched at the pre-set time.

"0": Deactivate timer. The function(s) return to the default setting

Press the "next" button for the functions to be controlled.

"1": Functions are set to their "on" settings and the timer is active. "0": Functions are set to their "off" settings.

Press SET to end programming.



System Telephones

Switching over the door call variant

ST 25

ST 30

Which phones are to ring when the bell push is pressed are set with the doorphone setting variant 1 and 2, day- night service call distribution setting. The doorphone class of service can be switched from any telephone, internal or external. If you change this from an external number then you have to dial the switch box which can be accessed via a DDI number on a PTP or a MSN number for a PTMP line.

If Night Service has been switched off, then Day Service is enabled.

Doorphone Night Service on / off

Press SET and the feature button Night Service Door or press SET 11 to switch the Door to Night Service.

Press next to select the Doorphone.
"1": Call variant 2 (Night Service) on
"0": Call variant 2 (Night Service) off

Press SET to end programming
The door is now set to Night Service which will be indicated by the '!' symbol.

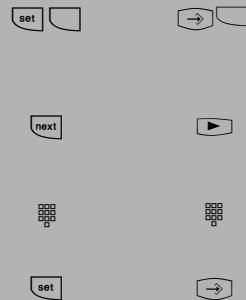

Note

Several features may be set simultaneously and indicated with the '!' symbol. If required features which have been set can be displayed by pressing the  several times.

System Telephones

Doorphone Diversion to External Number

ST 25

ST 30

You can divert your doorphone to any external number, including mobile, if you want to be contactable by a visitor even though you are not in the building. Regardless of the set diversion the internal extension will still ring and can also be answered by the extension.

If you divert to an ISDN terminal capable to display the calling number, then the identification of a doorphone call is possible and you can answer accordingly.

You can also enable or disable a programmed doorphone diversion from any external telephone. For instruction on how to do this remotely please refer to the user manual for analogue phones section 'Diverting a doorphone to an external number'.

Programming and Diversion of a Doorphone

Press the SET and function button DIVERSION TO or Press SET 17.



Enter the doorphone extension number which is going to be diverted



With 'next' select -diversion to outside line



Press "enter" to confirm the selection



Enter telephone number to which the call will be forwarded and press enter to confirm.



Select the condition for the diversion

1 = Permanent (All Calls)

2 = When Busy

3 = When no Answer

and confirm with enter



Press 1 to switch diversion on

Press 2 to switch diversion off



Press SET to end programming



Notes

The external number will ring for 30 seconds, after which the call is cancelled. The external Doorcall will be disconnected after 10 minutes. The door opener cannot be activated from a diverted call.

System Telephones

Operating the Doorphone and Door opener

ST 25

ST 30

You can speak to someone at the door if your system has a doorphone (TFE) connected to it. Your phone will ring with a distinctive ringing sequence if a visitor presses the bell push at the doorphone. The door call can still be answered 30 seconds after the last ringing sequence. (or for as long as the red LED flashes) The doorphone will be answered as soon as you lift the receiver on your phone. You also can activate the door opener from your phone whilst speaking to the doorphone. You can also Call Pick Up a doorphone call that rings at another extension. Your extension will be busy during the connection to the doorphone.

Answering a Doorphone Call

The receiver is on the hook.
The doorphone rings your extension.
Lift the receiver of your phone, you are now connected to the doorphone.
To release the door press the 'DOOR' button. The door opener is activated for three seconds. Your display shows a confirmation message and you will hear an acknowledgement tone.

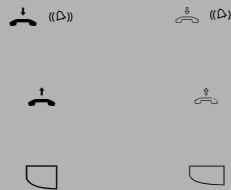

Calling the Doorphone

Lift the receiver
Press the DOOR button. The acknowledgement tone sounds. You are connected to the doorphone and can speak to the visitor.



Replace the receiver to end this operation



Notes

A DOOR feature button must be available at your extension if:
- You want to call the doorphone
- or you want to Call Pick Up a Doorphone
- or you want to release the door lock

press ESC to immediately cancel the lock release

System Telephones

Sending CLIP or COLP

ST 25

ST 30

The telephone system transmits your phone number to another ISDN subscriber before the connection is established (default setting of the system). Two types of settings are available within the ISDN network:

Forwarding the telephone number to the called party (CLIP = Connected Line Identification Presentation)

Your telephone number will be forwarded to the subscriber you are calling.

Forwarding the telephone number to the calling party (COLP = Connected Line Presentation)

Your telephone number is forwarded to the subscriber calling you. This ISDN feature will have to be ordered from your network provider.

Setting CLIP to on/off

Press SET 82

The current setting is displayed

1 = Send Number

0 = Withhold Number

Press SET to end programming

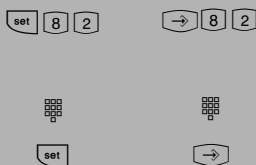

Setting CLIP to on/off with a function button

Press the "incognito" button to enable or disable sending of your number.



Setting COLP to on/off

Press SET 83 to set COLP to on or off.

The current setting is displayed

1 = Send Number

0 = Withhold Number

Press SET to end programming

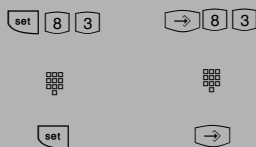

Notes



Your complete number will be sent to the network consisting of STD Code and DDI number or STD Code and MSN number, depending if the line is for system access (PTP) or standard access (PTMP). You must transmit a valid number belonging to you. If you transmit a number which is outside your allocated range then the telephone exchange will automatically replace this number with the main number allocated to the ISDN 2 e circuit.

System Telephones

Diversion from - Divert other Extensions

ST 25

ST 30

You can divert other extensions to your own which may momentarily not be staffed. After the diversion is enabled, the diverted phone will not ring for any further calls. Calls can still be made normally from the diverted extension. A special dial tone will remind the diverted extension that a feature is enabled in addition the '!' symbol will be displayed on both phones. Check status by   ... .

Diversion from - programming and switching

Press SET and the DIVERSION FROM button or Press SET 18
Enter the extension number you wish to divert to your own
Press enter
The extension is now in divert.
To cancel the divert press
next : next : enter (on ST 30 press right arrow and follow instruction) the setting is displayed Press clear

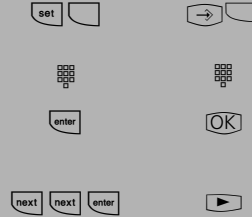

Notes

You can switch an already programmed "Diversion from" on or off on your phone with the "Diversion from" and "enter" buttons. The display shows:

```
13 permanently to  
telephone 11
```



```
13 deactivated to  
telephone 11
```

Returned Calls, Wake Up and Appointment calls cannot be diverted.

Calls can only be diverted once. Calls diverted to you are ringing your extension only even if you have set a 'Diversion to' on your phone.
A "Diversion from" a phone where the Do Not Disturb feature has been set to your extension is possible.

Status messages:

Several features may be set simultaneously and indicated with the "!" symbol. If required features which have been set can be displayed by pressing the  several times

System Telephones

Diversion to -diverting calls to another phone

ST 25

ST 30



Diversion via the Phone System

You are able to divert all calls for any phone either to another extension or via the second B channel to any number worldwide.

You are able to select:

- Divert all Calls
- Divert when Busy
- Divert no Answer (after 15 seconds)

The diversion to an external number can also be set up remotely from any number worldwide. For further set up instruction, please refer to your user manual in the analogue section under the heading 'Diversion – divert to another number'

After the diversion is enabled, the diverted phone will not ring for any further calls. Calls can still be made normally from the diverted extension. A special dial tone will remind the diverted extension that a feature is enabled in addition the '!' symbol will be displayed on the diverted phone and if applicable the internal target extension. Check status by   ... .

Diversion to - Program and Enable

Press SET and the DIVERSION FROM button or Press SET 17



Enter the extension number for whom calls should be diverted



Select with next if the call is to be diverted to another extension or an outside line.



Confirm the selection with 'enter'



Enter the extension number or outside number to which the calls should be diverted



Press ENTER to confirm



Select the type of diversion:

- 1 = All Calls
- 2 = When Busy
- 3= If no answer (divert after 15 secs)



Press ENTER to confirm



For activation press

- 1 Diversion enabled
- 0 Diversion disabled



Press SET to end programming

The ! symbol on your phone will indicate the active diversion.



System Telephones

Diversion to – enable feature with function button

Select this feature by pressing the DIVERSION TO function button the current status will be displayed. Enable or disable the diversion by pressing the ENTER button. If you press next you can switch the diversion on or off for the second extension number allocated to your phone. Return to the main menu by pressing ESC

ST 25



ST 30



Notes

A diversion will not be carried out if the call to be diverted has already being once diverted. Diversions to an extension where Do Not Disturb is set are not possible. Returned calls, Alarm and Appointment Calls cannot be diverted. A line must be available for diversions to an outside number. The diverting extension must have the correct line access level set in order to establish a diversion to an outside number. You will have to pay call charges for diverted calls.

Status messages:

Several features may be set simultaneously and indicated with the "!" symbol. If required features which have been set can be displayed by pressing the several times

After pressing and then you can display all diversions which concern your extension. The displayed diverted number can be cancelled by pressing

System Telephones

Call Forwarding

ST 25

ST 30

Diversion via the public switched telephone network. Call forwarding can only be setup if this feature has been ordered from your telephone exchange. If call forward is carried out on a Point to Point (PTP) connection then the entire line including all DDI's are forwarded. To forward individual DDI numbers via the telephone exchange and without busying your second B Channel you must have the feature PARTIAL RE-ROUTING enabled in the program of the telephone system.

Using this feature on a Point to Multipoint (PTMP) then partial re-routed does not need to be set as each individual MSN can be diverted. When using a call forwarding button on your phone you can select the line to be forwarded.

Call forwarding can also be programmed remotely from any telephone. For instructions on how to activate call forwarding remotely, please refer to your user manual for analogue extensions under the heading 'Diverting to....' A destination telephone number must have been programmed if you want to switch on or off call forwarding via a feature button. The following types of call forward are available.

- Forward all calls
- Forward on busy
- Forward on no reply

Programming a Call Forwarding Destination

Press SET and the CALL FORWARDING button or press SET 81 to program the forwarding destination.

Press NEXT to select the next free available entry.

Press ENTER to confirm

The first entered number will be displayed.

Press next to select a line which should be forwarded.

Press ENTER to confirm the selected line.

Enter the destination telephone number and press

ENTER to confirm.

Select the condition under which a call shall be forwarded ie

1 = All Calls

2 = When Busy

3 = When no Answer

Press ENTER to program another line or

Press SET to end programming.

You can enable or disable Call Forward with the 'ISDN Call Forward' button.

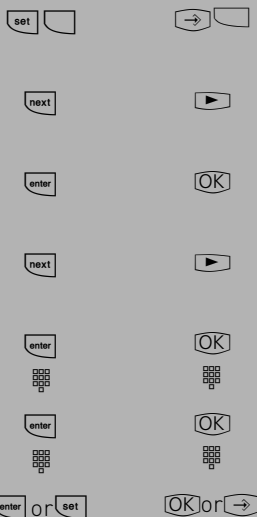

System Telephones

Call Forward on/ off

Press the 'ISDN Call Forward' button. The system will display for which line call forwarding is set and to which destination number and if this is enabled or disabled.

By pressing NEXT another line and number will be displayed if applicable.

By pressing ENTER you will enable or disable call forwarding for the displayed line. Wait until the display will confirm the activation. (Confirmation from ISDN exchange) This could take up to 60 secs.

Press ESC to return to the default display. The LCD will show '!' to indicate that Call Forwarding is active.

ST 25



ST 30



Notes

You can only enable or disable call forwarding with an "ISDN call forwarding" function button.

You can only program a call forwarding destination if this has not already been forwarded. Outgoing calls are unaffected if call forwarding has been set. You will hear a special dial tone from the telephone exchange whilst this feature is enabled.

System Telephones

Display and delete call charges

ST 25

ST 30

By using a "Units" button, you can display on a system phone the meter total and last call charge per extension which then can be deleted individually. If you delete the meter total of an extension then the last call cost will also have been deleted.

Reset Meter to Zero

Please take note of display details
enter 4 digit authorisation code
if required
Enter Extension number

Delete the displayed charges by
pressing CLEAR



Notes

Charges for doorphone call diversions to an outside number will be looged under the extension number of the door. (Txx)

Printing of Metered Call Charges

You can print the total of all call charges per MSN line, extension and cost of diversions of doorphones. Printing will be done via a connected serial printer. Depending on the setting printing can be done with either 24 or 80 characters per line. In addition you can select the line feed from 0 to 4 lines. The information printed will contain the date, time, subscribers number, extension or SO number, cost of the connection in units and amount. (If trariff charge units have been entered)

System Telephones

Setting the line feed for the Printer

The line feed of the printer can be set between 0 and 3 lines.

Enter program mode:



Set the desired line feed:

End programming:

ST 25

ST 30

 * 7 0 5 

 * 7 3 8 4 5  0,1,2,3 

 * 7 0 0 

Check in / Check out

By Pressing the button "Check in/out" the recording of call charges will be started on checking in, recording will be stopped and the charges will be printed on a connected printer on checking out. Additionally the Telephone Lock will be activated on checking out. You can programm the function button assigned to a special extension number or unassigned, so that a extension number has to be entered after pressing the button.

System Telephones

Call Charges – Display your own

ST 25

ST 30

Your telephone system can display call charges, if you have requested this feature from the network operator, either during or at the end of a call.

You can display

- charges during a call in progress
- available balance – if a charge limit has been set – charge of the last call
- your total call charges

Display Charges during a call

Whilst on a outside call.

The display of call charges on your system phone is enabled (SET 281), no charge limit set.

During an external call the first display line will indicate the call charges after receiving a meter pulse for max 5 seconds.

Otherwise the subscribers number will be displayed. You can display the charges for 5 second with the button 'UNITS'.

At the end of a call the charges will be displayed for 20 seconds after which the time will be displayed. The duration of the call will be displayed if no charges are received. The display of call charges on your system phone is enabled (SET281), charge limit set.

During an external call the first line of the display will indicate the remaining amount for max 5 seconds after each meter pulse.

Otherwise the subscribers number will be displayed.

The current charge limit can be displayed for 5 seconds with the button UNITS. At the end of a call the amount remaining will be displayed for 20 seconds after which the current time will be displayed.



System Telephones

Call Charges – Display the total of the last call

With the receiver on hook. Press the "units" button. The costs of the last call will be displayed.
Press the "next" button. If a charge limit has been set then the remaining available amount will be displayed. If no charge limit has been set then the current total of call charges are displayed. Press ESC or SET to end display of call charges.

ST 25



next

esc or set

ST 30



stop or →

Notes

No call charges will be displayed if the cost of a meter unit has not been set.
For technical reasons, the information on the network carrier's invoice may deviate from the total of the telephone system's call charges. The tariff cost of the network provider is always final.
If the call meter of the system is full, then call data has to be manually deleted. Alternatively you can enable with the assistance of TK Set under the heading connection charges that the data is automatically deleted after it has been read.

IMPORTANT NOTE:

On using analogue lines, call charges cannot be displayed or calculated!

System Telephones

System Redial

ST 25

ST 30

In the extended redial memory, the telephone system stores the last ten external phone numbers that you have dialled. You can select one of these external phone numbers and you can dial by simply lifting the receiver.

With the automatic redial feature, your system telephone makes 10 attempts to establish a connection to an external subscriber who is busy or who does not answer. If the external subscriber does not answer, the telephone is rung for 30 seconds. The system telephone then cancels the connection attempt. After every attempt, the system telephone inserts a break of 90 seconds. If the other party answers, you must lift the receiver or press the loudspeaker key as otherwise the connection will be cleared after 10 seconds.

You can dial any external phone number by means of the automatic redial function that is displayed when the receiver is on hook. This is the case after dialling preparation, after pressing the „redial” key or after the „destination” key or „phonebook”.

Extended redial

With the receiver on hook. Press the “redial” button. The last phone number dialled is displayed.



By repeated pressing of the “redial” button, select one of the 10 last phone numbers displayed. Lift the receiver. The displayed phone number is dialled.



Automatic Redial

With the receiver on hook press the redial button. The last number dialled is displayed. Automatic redial will start once you press the enter button. The green LED will flash. The LCD will display how many more times the system is trying to the requird number. The speaker will be switched on automatically once the connection has been established.



Pick up the receiver or press the speaker button as otherwise the line will be cleared down after 10 seconds.



Notes

A phone number which has been dialled via the single button dialling or the phone book will not be stored in the redial memory. Automatic redial can be cancelled at any time by pressing any button on your system phone.

System Telephones

Wake Up Call – Repeated Appointment Call

ST 25

ST 30

You can place a Wake Up Call from your phone. The Wake Up Call will ring your phone for one minute with increasing volume. The snooze function can be activated at the push of a button during the wake up call which will then be suspended and repeated every 10 minutes for a maximum of one hour. The wake up call will be completed once you lift and replace the receiver. The Wake up call will ring your extension even if do not disturb is set. A bell symbol will be displayed in the LCD to indicate that this function is set. (ST30 phone will display a clock, DECT 30 will display a W.

Set Wake Up Call

Press SET & Wake Up Call
or Press SET 16.

Enter the time as HH:MM in the 24 hour
format. Press ENTER
Press shift and clear to delete an earlier
entry if applicable.

Select the day of the week for which the
Wake Up Call should be set:
1-7 for days from Monday to Sunday
8: Monday to Friday
9: all weekdays
confirm with OK
press 1 and SET to store and activate the
entered Wake up Call. The display will show
a bell symbol as confirmation.

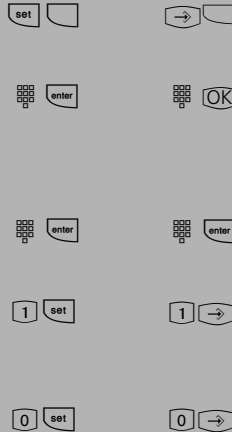

Switch on Wake Up Call

Press the button Wake Up
The first line of the display will show
the stored time. The Wake Up Call is now
switched on. Press ECS to return to the
standard display.



Switch off Wake Up Call

Press the button Wake Up
The first line of the display will show
the stored time. The Wake Up Call is
now switched off. Press ECS to return to
the standard display.



System Telephones

Receiving a Wake Up Call

ST 25

ST 30

The Wake Up Call will ring your phone at the set time and the LCD will display WAKE UP CALL. Press the ESC button to switch off Wake Up for today. The next Wake Up Call will ring your phone again at the same time the next day.



Notes

The Wake Up call will only work if you have activated it. To switch off the Wake Up Call, press the Wake Up button.

If set to on the Wake Up Call will ring every day at the same time.

The Wake Up Call will not ring your phone if you are on a call, but will ring as soon as you replace the receiver.

Wake Up Call will ring your phone even if you have set a divert for it.

World Clock

It is possible to display different time zones on the ST 30 instead of status information. Different places can be set via system programming tool. (see instruction in TK Suite)

World Clock enable / disable

Display of the World Time Clock.

1 = disable
2 = enable
confirm with OK
end programming

You can scroll between different time zones with the arrow buttons whilst the display is in the idle status. The times zones will scroll automatically if > is displayed.

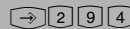

System Telephones

Single Button Dialling

ST 25

ST 30

Your system phone can store up to 20 different telephone numbers. Numbers can be called at the push of a button. Each feature button can be programmed to store a personal number, not accessible from other extensions. Feature buttons can also store numbers from the central phone book. Numbers stored can also be alpha tagged. (See notes on how to alpha tag numbers)

It may have been set in the program of the telephone system which buttons are allocated on your phone for single button dialling. Each function button has two levels. See also Changing function button assignment 2'.

Storing a Number from the Phonebook

Press SET & Function Button to be programmed
(if you program the button for the second level, then press the shift button first followed by the function button)
From the Phonebook select the number required.
Confirm your selection with ENTER.
Press SET to end programming.

(see Phonebook dialling for information on how to retrieve numbers)

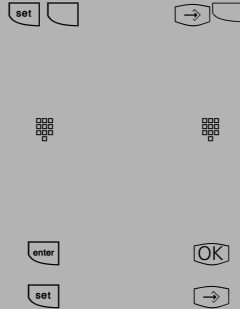

System Telephones

Storing a Personal Number

Press SET and select function button to store number into. (if you program the button for the second level, then press the shift button first followed by the function button)

If applicable a number already stored will be displayed.

Enter the full telephone number you wish to store. You can overwrite an existing entry or press clear to delete the entry first.

Confirm your entry by pressing enter.

Enter a name (see page 1 - 62) and

confirm with "enter" or "OK".

Press "enter" or "OK" to program further buttons or press "set" to end programming

The number stored will only be available to your extension.

ST 25



ST 30



Single Button Dialling

Lift the receiver and press the destination key. The stored telephone number is displayed and dialled. The outside line is seized automatically. When the other party answers, conduct the telephone conversation in the usual manner.



Notes

Enter the number to be stored without the line access digit. The line will be seized automatically.

If a number is already entered in the selected location, then press CLEAR to delete this entry. To keep a number displayed, press ESC and select different button.

Overdialling: Press the required Memory button in which part of the number is stored, and complete dialling by adding the required digits.

System Telephones

Telephone Answering Machine (TAM)

ST 25

ST 30

An AGFEO ST 30 system phone can be expanded with a 'A Modul 30' telephone answering machine. The answering machine can be switched on or off from any extension or remotely from any telephone number. The module can be recorded with two messages, one for normal operation and one for announcement only mode.

If the ST 30 is programmed with a primary and secondary extension number then the answering machine can answer each number with a different message in turn. (Like having two answering machines) The two extension numbers will work totally independent from each other and each machine can be switched on or off as required.

Switch on / off (from another extension)

Remote activation
Dial the extension number of the answering machine followed by the digit for the required setting.
2=Answer on
1=Announcement only on
0=off
Acknowledgement tone is returned.

Replace the receiver.



Groups

You are part of a group if your extension number has been allocated to a group number. (please refer to TK Suite).

You can log in or out of the group with a function button programmed as ,GROUP'. The sequence of the call distribution is important (for even call distribution within a hotline for example) and will not change if a group member will log in or out of the group. A maximum of up to 20 groups can be formed and every extension may be a member of every group.

System Telephones

Log In / Log Out

ST 25

ST 30

Press the button GROUP. If you have been logged into a group the display will show LOGGED OUT FOR GROUP NN. Whereby NN is the group number or group name. If you press the GROUP button again then you will be logged in again and the display will read LOGGED IN FOR GROUP NN.

If you do not specify the group number, then the function will be carried out for all groups you are a member of. The call sequence as defined with TK Suite will not change.

Analogue and ISDN-Phones

External Line Access

Depending on your preference the system offers different modes to connect to an outside line. Spontaneous seizure with internal will connect any number dialled to the exchange line. To dial an extension you prefix the extension number with #. If your phone has no # button then you are unable to make any internal calls. If you set the access to spontaneous then on lifting the receiver you will hear external dial tone. With this setting you cannot make any internal calls. This setting could be used for a faxmachine or a payphone. If you select the setting with access digit then you have to dial 0 (or 9) to get an outside line. In this case you would dial 9 and the required telephone number or the two digit extension number to make an internal call.

Setting External Seizure

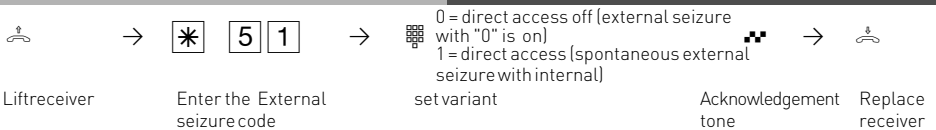

Making a Call

To make an internal call, pick up receiver and dial the 2 digit extension number. Note: Each extensions can have two separate numbers. Please contact your Telephone System Manager for an Internal Telephone Directory.

To make an exchange line call depends on how your telephone system is programmed. For users who's extension is set to 'Spontaneous line seizure with internal' just need to dial the the required telephone number. If you would like to make a call to another extension on your telephone system, then please prefix the extension number by #.

If a line access digit is set then you have to dial 0 (or 9 as the case may be) to get an outside line and then dial the telephone number required. If you would like to call another extension on your system, then just dial the two digit extension number.

If Call Forwarding is active on your line, then you will hear a special dial tone from the telephone exchanger after you connect to the line. This will remind you that this or another feature may be set in the exchange

Making a Call (Using Acces digit)

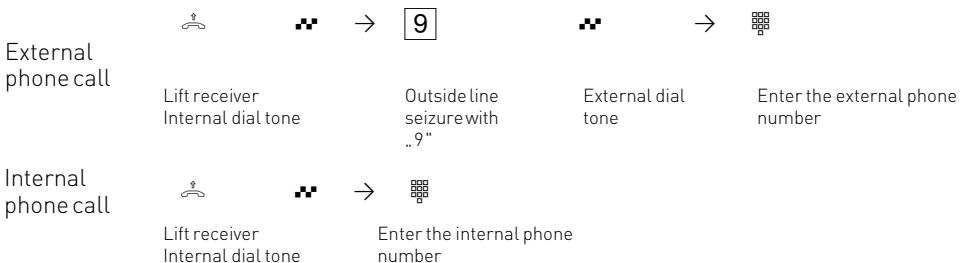

Analogue and ISDN-Phones

Making a Call (Using Acces digit)

Forwarding your number. The telephone number which has been allocated to your extension will be forwarded to the called party. You may also forward an alternative number if this is available to you by selecting another line or MSN number via a *-procedure.

Making a call spontaneous seizure with internal

External
call



Lift receiver
External dial tone

Enter external phone
number

Internal
call



Lift receiver
External dial tone

Press the
hash key

Internal dial
tone

Enter internal phone
number

Analogue and ISDN-Phones

Spontaneous Outside Line Seizure (no internal calls)

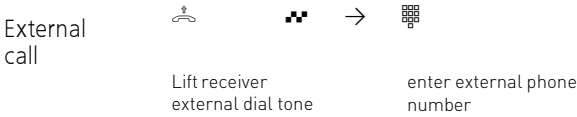

In this mode no internal calls can be made.

External Acces with specific MSN

You may send another MSN number other then the one allocated to you to the network.

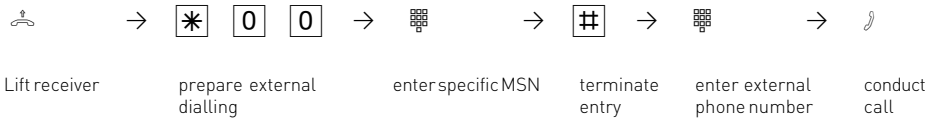

Reserving an outside line (Call Back when free)

On requesting an outside line you will hear busy tone if all lines are engaged. You may now request for a line to be reserved. As soon as an outside line becomes free the system will phone you back. When picking up the receiver you will hear external dial tone and can dial your number.

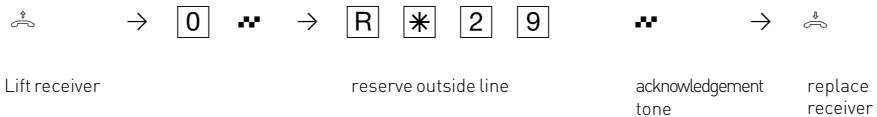

Analogue and ISDN-Phones

Notes

If Error tone is returned to you after dialling the line access code then your extension is call barred.

Barred Calls – You will not be able to make calls for which your extension is call barred. If you try and make a call to a barred number, error tone will be returned to you.

Internal call - Internal dialling is not possible on telephones for which spontaneous outside line seizure with internal is set and which do not have a **#** key (hash key) or which do not support this key.

DTMF signalling -Is possible to send DTFM Tones during a connection. This can also be done during an enquiry call, Brokers Call and Three Party Conference. Any digit from 0 – 9 including * and # can be transmitted.

An outside line which has been reserved will only ring your extension for 60 seconds after which the call back for the outside line will be cancelled.

If an error tone is returned when booking a reservation for an outside line, then this means that the line has already been reserved by another extension.

You may dial 99 on telephones which do not have a ***** button.

Analogue and ISDN-Phones

Accepting Incoming Calls

Incoming calls will be signalled with a different ringing cadence for incoming-, extension- and doorphone calls. You can also be called whilst already on a call, this will be indicated to you by a call waiting tone in your handset.







You are called

«D» →  → 

lift receiver

conduct the call

Call waiting

  →  «D» →  →  

You are on a call and hear the call waiting tone

End the call

Automatic ringing by the waiting party

Lift the receiver

Conduct the call

External call waiting (free outside line)

  →  →   → 

You are on a call and hear the call waiting tone

Press R the call is placed on hold

Answer the waiting call

conduct the call

Internal call waiting

  →  →  → 

You are conducting a call and you hear the call waiting tone

Inquiry, the call is placed on hold

Fetch the waiting - internal call

conduct the call

Analogue and ISDN-Phones

Rejecting an external waiting call



Notes

If you hear error tone when trying to answer a waiting call, then the call waiting tone is for the other party.

The call waiting tone can be switched off by setting .Call waiting deny

Call Transfer

You can transfer an incoming call to an extension or another external number. When transferring a call to an extension you can announce the caller before replacing the receiver.

Internal Transfer with announcement

You call the extension in an enquiry, you announce the external call and you replace the receiver. You have now transferred the external call.

Internal Transfer without announcement

Press the R button and dial the required extension, replace the receiver on hearing ringing tone.

External Transfer is only possible with an announcement

Whilst on a call place the existing call on hold and call the other required party. Announce and transfer the call.

Analogue and ISDN-Phones

Internal Transfer with announcement

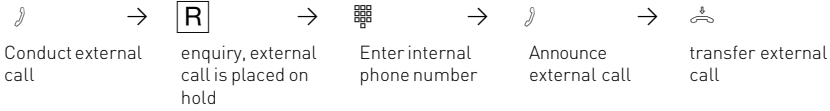

Internal Transfer without announcement

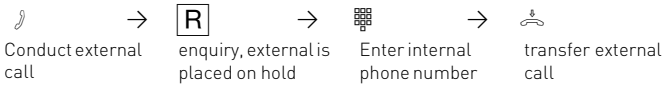

External Transfer

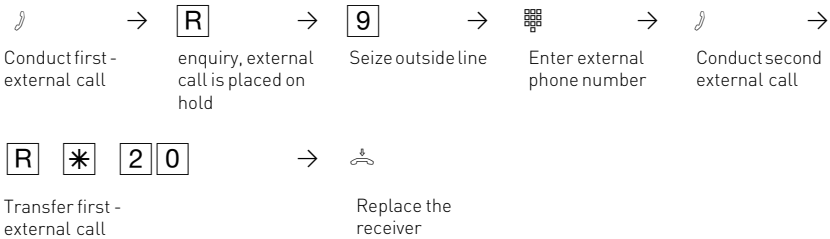

Notes

When transferring an external call, you must always seize the outside line by entering „9“, even if spontaneous outside line seizure with internal is set on the telephone.

External Transfer is only possible if a dial-up line (B-channel) is free.

You bear the cost of the externally transferred call.

A user on the internal S0 bus can only forward an external call internally if the second B channel of the internal S0 bus is free. External/external Transfer is not possible.

Internal Transfer with announcement

If the internal user does not answer, you are connected back to the external subscriber after dialling [R][9]. If necessary, you can transfer this external subscriber to another internal user.

During an enquiry call the outside caller will hear Music on Hold. (if activated)

A unannounced transferred call will be returned to you after 45 seconds if the extension fails to answer it. The call will be cleared if you also fail to answer the call within 60 seconds.

Analogue and ISDN-Phones

Call waiting / Call Back when free

An extension already on a call will hear call waiting tone if called by another extension or outside call. If the extension does not answer your call then you can request ringback when free.

Request Ringback when free



Lift receiver



busytone



Enquiry



Request
Ringback
when free

Analogue and ISDN-Phones

Notes

Call waiting announcement - You cannot announce yourself as a waiting caller to an internal user

- from whom a callback is already expected.
- whose connection is set to the answering machine, fax, modem or combined unit terminal type,
- who has activated call waiting protection on his telephone.

If you wish to repeatedly announce a waiting call to an internal user without placing a call on hold, you must announce your call again.

Callback - You can initiate several callbacks in succession (from every internal user)

You cannot initiate a callback from an internal user

- from whom another user is already expecting a callback,
- who has activated do not disturb on his telephone,
- whose connection is set to the answering machine, fax, modem or combined unit terminal type,
- who has activated call waiting protection on his telephone.

Callback from a user with a standard -telephone:

- The callback is cancelled after 60 seconds if you do not pick up the receiver.
- A callback is cleared automatically once it has been established.

Callback in general:

You have activated a callback:

- if you have activated do not disturb on your telephone, this is temporarily -cancelled.
- if you have set call diversion on your -telephone, the callback is not diverted.
- Power failure: initiated callbacks are cleared.

Call list - Callback from a user with a -system telephone:

- If you do not pick up the receiver, after 60 seconds your call is entered in the call list of the user's system telephone.
- If you are busy, your call is immediately entered in the call list.
- If the user picks up the receiver during his callback, your call is immediately entered in his call list.

You cannot use the „call waiting -announcement/callback/call list“ features on a combined unit (phone/fax).

Analogue and ISDN-Phones

Call Waiting

A call waiting to be answered can be signalled with the CALL WAITING TONE whilst already on a call. This tone is an audible sound indicated in your handset. This feature can be switched on or off. If this feature is set to off, then callers will hear the busy tone when your extension is in use.

Call Waiting on / off

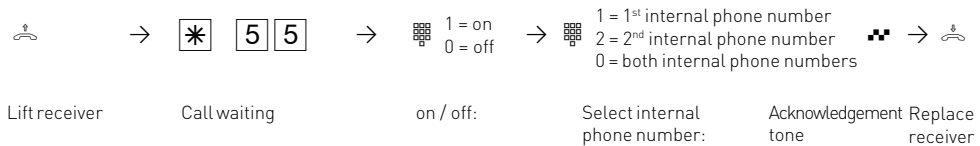

Call Pick Up

Another telephone rings with an external or an internal ringing tone. You can pick up this call on your telephone. You can also pick the call up if the answering machine has already answered it.

Unselective Call Pick Up of an external call

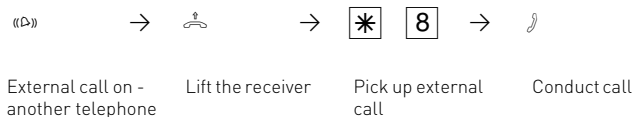

Selective Call Pick Up

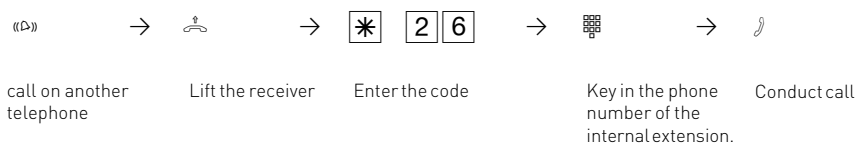

Analogue and ISDN-Phones

Pick Up a door call



Door call on another telephone Lift the receiver on your telephone Pick up door call Doorphone Number Conduct call

Pick Up (from Answering machine)



Answering machine has accepted external call Lift the receiver on your telephone Enter the answering machine's internal phone number Conduct external call

Notes

To be able to pick up a call from an -answering machine, the terminal connection must be programmed as an answering -machine. You can only pick up external calls non-selectively. You can selectively pick up the call signalled to the selected extension.

Do Not Disturb

You do not wish to be disturbed by calls and you activate the do not disturb feature.

You can select whether the don't disturb feature is to apply for your 1st internal phone number (primary internal phone number), your 2nd internal phone number (secondary internal phone number) or for both internal phone numbers.

You can also define whether do not disturb is to apply only to internal calls, to external calls or to all calls and you can deactivate do not disturb again.

If do not disturb is active, ringing on your telephone is off and internal callers hear the busy tone. You can continue conducting telephone calls in the usual manner. When you pick up the receiver, the special dial tone reminds you that the do not disturb feature is on.

Analogue and ISDN-Phones

Do Not Disturb on/off

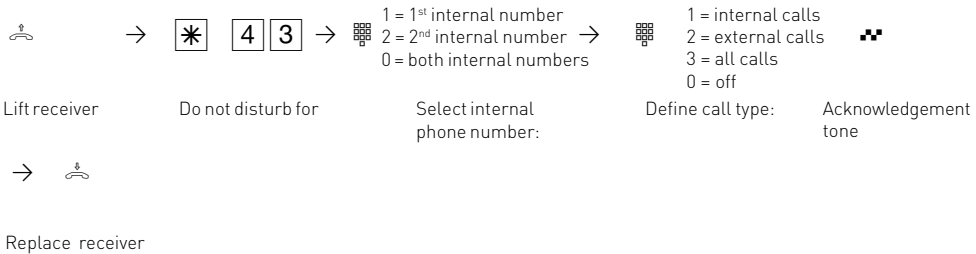

Notes

You can initiate callbacks despite the fact that the do not disturb feature is active. The callback temporarily cancels do not disturb. Do not disturb is not active if you are using your telephone as a guarding telephone for room monitoring.

Switching between Day and Night Service

Which extension should ring on an incoming call is set in the 'Call Variant' under Day/ Night Service. If several extensions ring on an incoming call then the one who picks up the receiver first will have answered the call. An incoming call can ring different extensions depending if the system is running under Day or Night Service. Night Service can be set for each incoming line separately. Day - Night Service can be activated from any extension on the system or remotely. Please refer to the operating instruction for an analogue phone on how to switch Day- Night Service from an external phone.

Night Service on / off

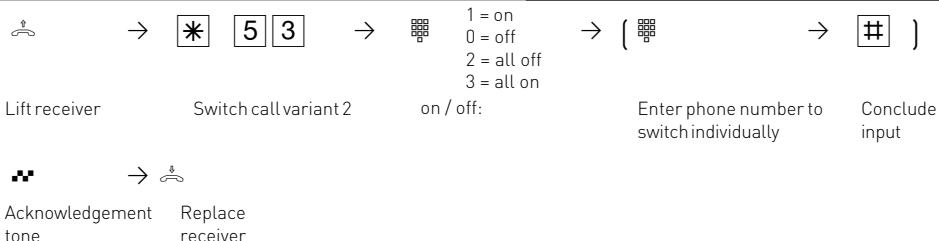

Analogue and ISDN-Phones

Night Service on / off from an external source

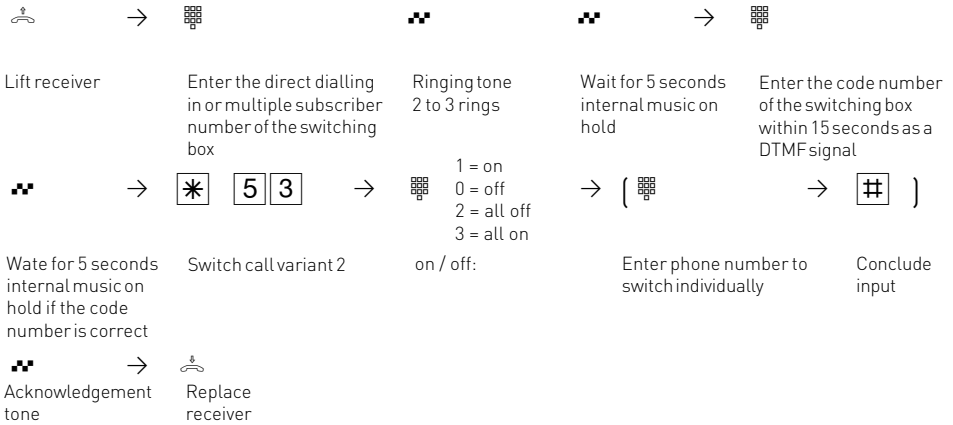

Notes

If the selection 'all off/all on' is set up when Night Service is switched on/off, door call variant 2 is switched on/off at the same time.

Switching Call Forwarding (Extension Call Forwarding) on/off

With this setting incoming calls can be forwarded to alternative extensions if:

- after a preset number of rings the call remains unanswered.
- Immediately if the telephone is busy and call waiting indication is not possible.

This feature can be set at any time from any extension or remotely for any exchange line connected to your system.

The Call Forwarding is set for each extension in the programming table of the Call Forward section.

Analogue and ISDN-Phones

Internal Call Forwarding on / off

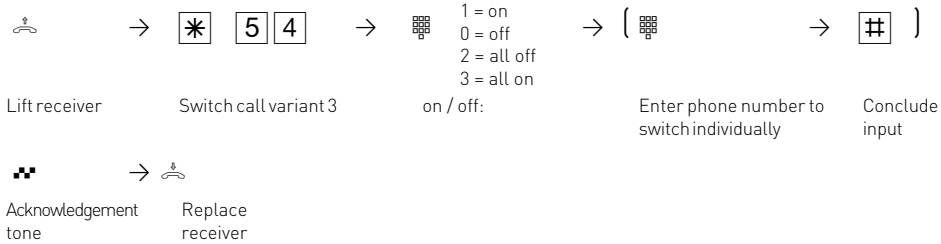

Internal Call Forwarding on/off from an external telephone

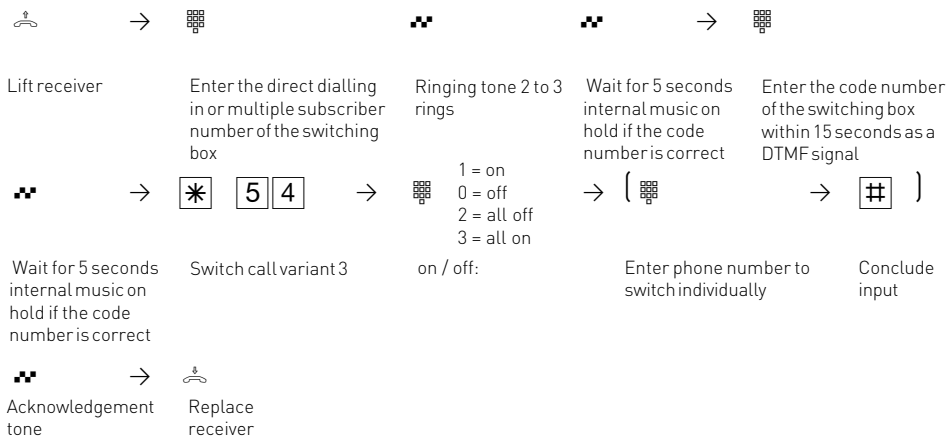

Analogue and ISDN-Phones

Auto Dialling (Hotline)

With this feature a pre-set number is dialled within 10 seconds after lifting the receiver. Calls can still be made normally providing dialling commences within 10 seconds.

Switch Auto Dialling on/off

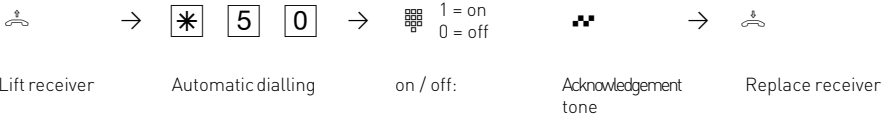

Storing a Number for Auto Dialling

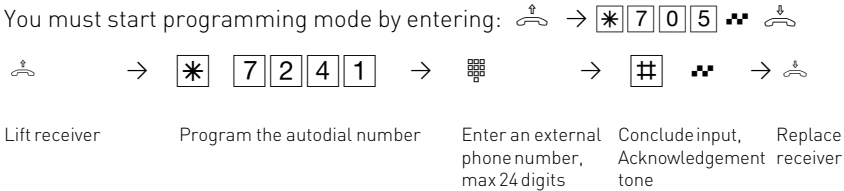

Continue programming or end the programming mode by entering:

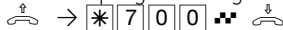

Deleting the Number for Auto Dialling

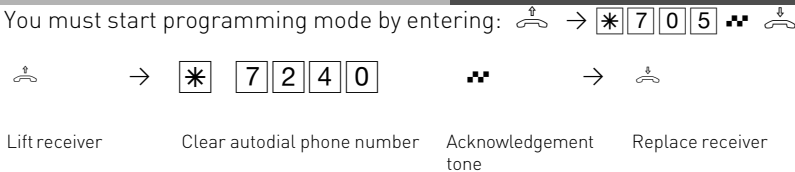

Continue programming or end the programming mode by entering:

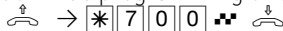

Analogue and ISDN-Phones

Notes

Check your Auto Dialling setting after programming the external phone number. Activate the Auto Dialling mode, lift the receiver, wait -until the external phone number is dialled and check that the right connection is -established.

The Auto Dialling function has preference over all other external connections. If necessary, one line (one B-channel) will be force released in order to complete autodial.

If the called party is busy, the telephone -system attempts to redial the external phone number every 10 seconds.It cancels Auto Dialling after 12 -attempts.

If you hear the error tone when you activate the Auto Dialling feature, no telephone number has been programmed.

If the Auto Dialling feature is on, you hear the special dial tone when you pick up the -receiver.

Busy on Busy

This feature is used in the following situation. If an incoming line is programmed to ring several phones, then each time a new call arrives the free extensions within the group will ring. If, however, for some reason your are the only one in the office and are already on a call then the next incoming call would cause the free extensions to ring. It may not be possible to answer the new call in time and therefore the caller may get the impression that no one is in the office. If Busy on Busy is set on the other hand than any extension within the ringing group who is on a call will cause for a new caller to hear busy tone. Note: This will not place restrictions on outgoing calls.

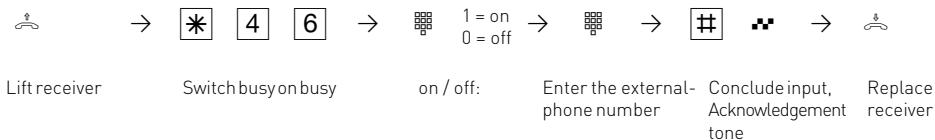

Notes

An ISDN terminal that is connected in parallel to the telephone system on a point-to-multipoint line and to which the same number as the system has been assigned will always ring, regardless if BUSY ON BUSY is active or not.

Analogue and ISDN-Phones

Voice Message Announcement







You can use your telephone system like an intercom, i.e. you can make a voice message announcement to system phones connected to the system in the form of a:

- Announcement to one, a group or all system telephones
- Announcement to a defined group of system telephones (see "Group formation").

The speakers of the system telephones receiving the announcement are automatically switched on, unless they are busy on another call.









You can also make a voice message announcement out of an external call.

Voice Message to a System Phone or Group

 →    →   → 









Lift receiver Enter the announcement code Enter the internal phone number of a system phone or group Acknowledgement tone Make the announcement

Voice Message to all system Phones

 →    →    → 

Lift receiver Enter the announcement code Announcement to all system-telephones Acknowledgement tone Make the announcement



Voice Message out of an External Call

 →  →    →   → 

You are conducting an external call Inquiry Enter the announcement code Enter the internal phone number of a system-telephone or 00 for all system telephones Acknowledgement tone

 Make the announcement

Notes

You can connect back to the external -subscriber after entering   if the -announcement party does not answer or is busy.

Analogue and ISDN-Phones

To place a Call on Hold

You can put a call on hold in order to make an enquiry call via the ISDN exchange, however this is only possible if your line is a Point-To-Multipoint connection. Note: This feature may not be available from your network provider. (not available from network providers in the UK)
This feature would allow you to make an enquiry call to another outside number even though no line (B Channel) is available. The call is put on hold in the exchange therefore releasing a line to be used to set up another call. You then can alternate between the calls by using the SPLIT button.

Place a Call on Hold (may not be available from network providers)

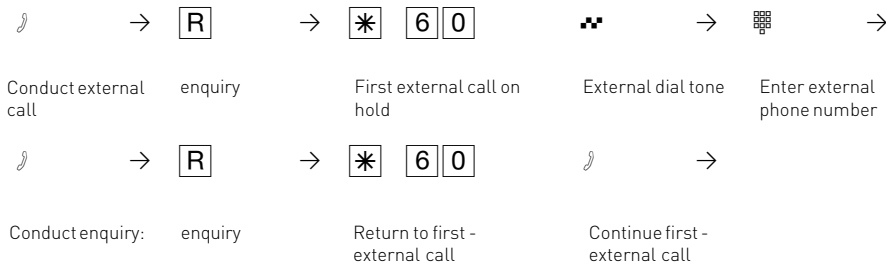

Notes

A call cannot be placed on hold in the exchange if you hear the error tone. You are connected back to the other call by entering **R0**.

When you replace your receiver, you will clear both calls, the current and the holding one. Call charges are incurred for the current call and for the one on hold.

Analogue and ISDN-Phones

Remote Dial Functions

With this feature it is possible to dial a number on behalf of another extension. (i. e. the Secretary for the Manager)

This feature must be enabled on the extension for which calls can be made.

At the time system phones only can set up calls for other extensions.



The following options are available:

- Remote Dial all (every extension can set up a call for you)
- Remote Dial off
- Remote Dial allowed from extension/group
- Remote Dial allowed via CTI
- Remote Dial switches system telephone to handsfree and dials number (system phones only).



Remote Dialling

The following options are available for analogue phones.

- Remote Dialling off/on (allow for all)



 → * 4 1 2 1 →  0 = off
1 = on → 

- Remote Dialling allowed from extension



 → * 4 1 2 2 →  nn → 

Enter the internal number

- Remote Dialling allowed via CTI per port

 → * 4 1 3 →  0 = off
1 = on → 

- Remote Dialling with automatic cradle switching
(system telephone dials automatically)

 → * 4 1 4 →  0 = off
1 = on → 

Analogue and ISDN-Phones

Malicious Call Identification (MCID)

This feature will have to be supplied by your network provider.
The ISDN exchange will store the callers number and the date and time of the call.
This trace can be activated during the call or after the caller has hung up but must be activated before you terminate the call.

Tracing a Call

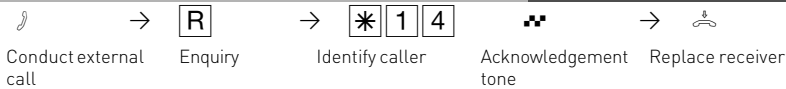

Notes

You can continue the call after **R*14**.
Until you return to the caller he will hear Music on Hold if applicable.
You hear the error tone if:
-Malicious Call Identification has not been made available by your network operator
OR
-when the caller could not be identified by the telephone exchange.

Conference

Three Party Conference via your Phone System

You can hold a three party conference with analogue or digital extensions of the system.
Or with one external call and one extension
Or with two external calls. Note you will use 2 lines (B Channels)

Three Party Conference via the ISDN Telephone Exchange (PTMP lines only)

Note this service is a feature of the Telephone Exchange and may not be available.

To establish a three party conference via the exchange you must first establish the call with the first party. Then hold the call in the exchange to establish an enquiry call on the same line to the second party after which you will switch to a three party conference.

Analogue and ISDN-Phones

Three Party Conference (with two other extensions)

📞	→	[R] 📞	→	📞	→	[R] [*] [6] [1]	📞 ✖
You are conducting an internal call		Enquiry, enter internal phone number		Conduct inquiry call		Enquiry, enter conference code	Acknowledgement tone, Conference with three parties

Internal - External Three Party Conference

📞	→	[R] 📞	→	📞	→	[R] [*] [6] [1]	📞 ✖
You are conducting an internal or - external call		Enquiry, enter „[9]“ and external or internal phone number		Conduct inquiry call		Enquiry, enter conference code	Acknowledgement tone, Conference with two internal users and one external subscriber

ISDN Three Party Conference

📞	→	[R]	→	[*] [6] [0]	📞	→	📞	→
Conduct external call		Enquiry		First external call on hold in the exchange		External dial tone		Enter external phone number
📞	→	[R]	→	[*] [6] [1]	📞	✖		
Conduct inquiry		Enquiry		Code for ISDN three-party conference		Acknowledgement tone	Three-party conference with two external subscribers	

Notes

Three Party Conference via the Telephone System.

An incoming – or doorphone call will be signalled to the conference with the call waiting tone if the called extension is part of the conference.

The Pick Up of a call is only possible by the extension who established the conference (Conference Manager) by pressing [R][*][8]. The conference manager can pick up a door call by entering [R][*][1][1]. The other members of the conference are put on hold until the conference manager has finished the enquiry call by pressing [R][R] after the conference is re established. If an extension replaces the receiver then that extension is disconnected from the conference and can only be re invited via the conference manager. The conference is cancelled as soon as the conference manager replaces the receiver.

Conference circuit via the ISDN exchange

Call charges are incurred for every participant of the conference. If you hear an error tone instead of an exchange dial tone, then the holding of a call in the exchange is not possible. Press [R][0] to return to the original call. You end the conference by replacing the receiver. You are connected to the party that you last invited into the conference. The first called party is put on hold.

Analogue and ISDN-Phones







Least Cost Routing (LCR)

This feature will make use of various network providers offering cheap call rates. Calls are routed depending on the STD Code dialled which is also dependent on the time and day of the week. If it is not possible to connect to the relevant provider after a preset number of attempts then the system will try to route the call via a preset alternative provider. (Fallback)

The access code of the relevant provider will be prefixed by the system to the number dialled.

The Least Cost Routing can cater for up to 8 network providers in 8 time slots depending on time of day and day of week. Least Cost Routing can be programmed with TK-LCR on your PC. Least Cost Routing can be switched on or off on your extension.

Switching Least Cost Routing on/off

 →    →  1 = on
0 = off  → 

Lift receiver Code for LCR on / off: Acknowledgement tone Replace receiver

Notes

You can still select which network provider is used for your call despite LCR being enabled.

- Simply prefix your number with the network access code
- You can also select the network provider with the function button CALL BY CALL on a system phone. (see also Network access code -Call by Call).

The network access code for the network operator is only stored in the last number redial memory if this has been dialled manually before.

Important! Not all ISDN features described may be available. Please check with your network provider for availability.

Parking a Call

You can park an external call in the system and retrieve this from another extension.

The parked call will engage the line (B Channel). The parked caller will hear Music on hold (if enabled). Calls parked will recall your extension within 4 minutes if it has not been retrieved.

Calls can also be parked or retrieved with an index number. This feature is useful if several calls are parked at any time.

This function can be activated in the configuration section 'other functions' or via a program entry on the phone.

Analogue and ISDN-Phones

Parking / Retrieving a Call

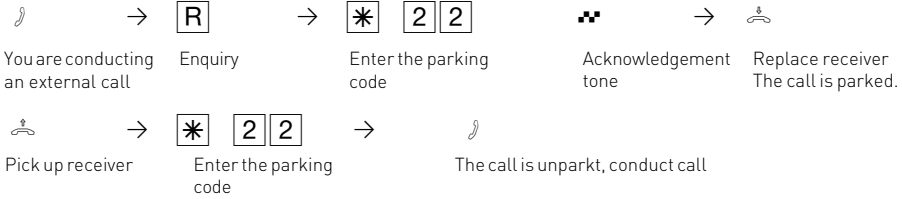

Activating/deactivating Parking with Index Number

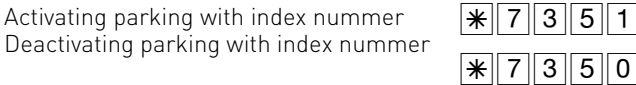

Parking/ / Retrieving a Call with Index Number

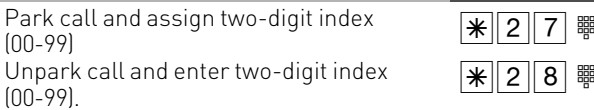

Notes

You can retrieve a parked call from any telephone.
On the standard phone dial ***22** to retrieve a parked call. If several calls are parked then the first one will be returned. Outgoing call incur charges when parked.

Baby Listening / Room Monitor

Any phone can be used for this feature (system- or standard phone) The phone set to Room Monitor (Baby Listening can be called from any telephone either internal or external). A system phone when called will switch on the microphone automatically. This feature must be enabled for the phone intended to be used as as monitor. You can select whether or not a warning tone sounds when listening into a room. The monitor phone can be called from any phone either internal or external. Please refer to the instruction manual chapter 'Room monitoring from an analogue phone' on how to access this feature from an external phone.

Analogue and ISDN-Phones

Set Up Room Monitor

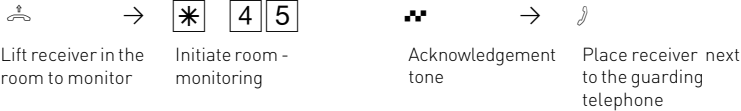

Calling the Room Monitor Extension

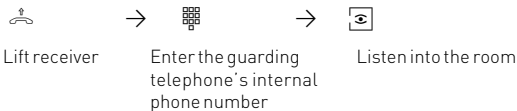

Calling the Room Monitor Extension from external

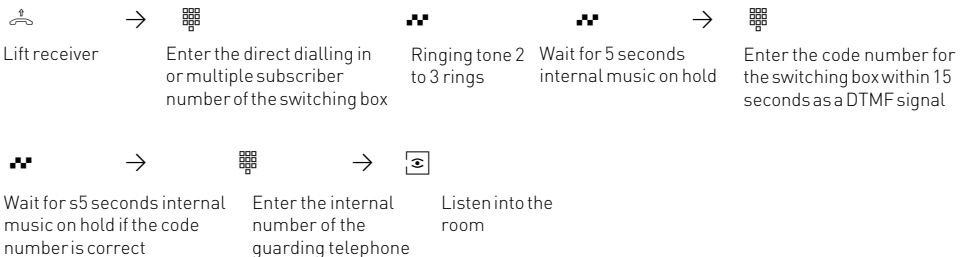

Cancelling room monitoring

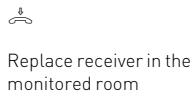

Notes

You can also use a telephone in the hands free mode as the guarding telephone. You cannot use an ISDN telephone on the internal S0 bus as a guarding telephone. The internal phone number of the switching box must be entered as the only internal phone number in the call variants (ringing distribution settings) of one multiple subscriber number. If you hear the busy tone after dialling up the guarding telephone, the room is already being monitored by another caller. Within 15 seconds you must enter the right code number as a DTMF signal with a DTMF hand-held transmitter or telephone as otherwise the telephone system will clear the connection. Please note, you can also be heard at the monitored phone.

Analogue and ISDN-Phones

Switching Relays

The telephone system has two potential free relays R1 and R2 which can be switched remotely. You could activate a bell or another door opener.
If no door phone TFE 1 (FTZ 123 D12) is connected to the telephone system then the relay contacts T0 (relay R3) and TS (relay R4) can also be used for other functions.

Relay on / off

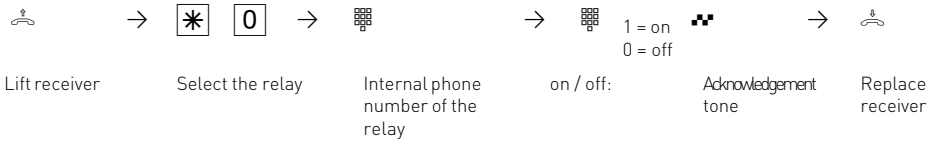

Relay on / off from external

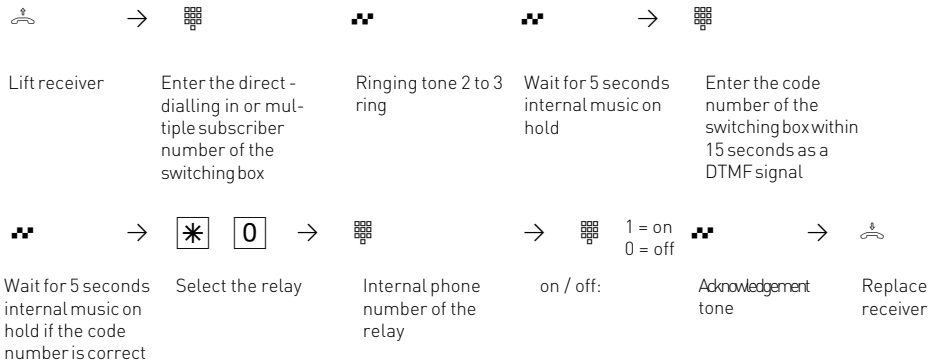

Notes

The internal phone number of the switching box must be entered as the only internal phone number in the call variants (ringing distribution setting) of one multiple subscriber number.

You must enter the right code number as a DTMF signal with a DTMF hand-held transmitter or telephone within 15 seconds as otherwise the telephone system will clear the connection.

Analogue and ISDN-Phones

Enquiry

You can place your current call on hold, while you talk to an extension or another external call. The caller on hold will hear Music on Hold and can not overhear your conversation. Whilst on an enquiry call you can use all functions such as telephone book, paging etc.

Internal Enquiry

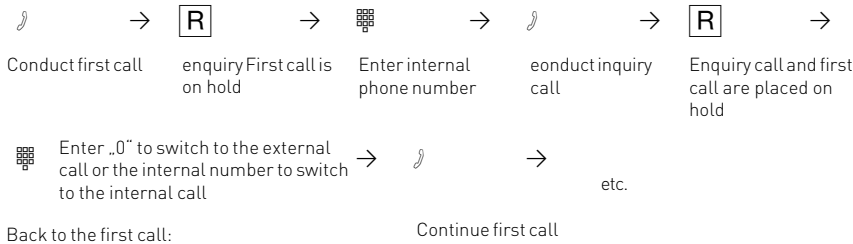

External Enquiry

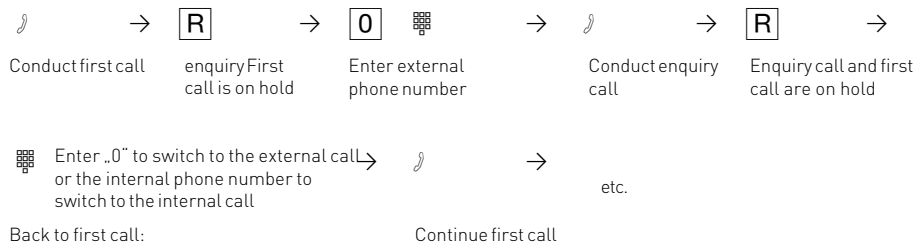

Enquiry (Mute)

To talk to another person in the room without the caller being able to hear:

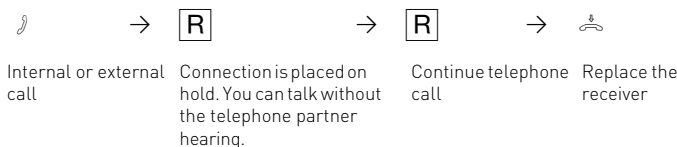

Analogue and ISDN-Phones

Notes

When making an external enquiry / brokering you must always seize the outside line by pressing „0“, even if spontaneous outside line seizure with internal is set on the telephone. An outside caller will hear Music on Hold if placed on hold.

If you replace the receiver during an enquiry:

- You clear the current call,
- You receive a callback if a call is still on hold,
- You transfer an external call on hold to the internal user with whom you were in an enquiry.

Connection charges are incurred for the external call, even while the call is on hold.

Automatic Call Back

You can set up an automatic call back if the number you are calling is busy. This feature is only available to subscribers of ISDN lines. Your phone will ring as soon as the called party replaces the receiver. The other party will be called automatically as soon as you pick up your receiver.

Set Up Call Back



Lift receiver



Call the external subscriber, busy tone, the subscriber is busy



Set Up Callback



Acknowledgement tone of the exchange



Replace receiver

Notes

If you hear the error tone then it will not be possible to be called back from the busy number. The feature Call Back on busy is not available from the telephone exchange. The feature will be cancelled if you do not answer the returned call within 20 seconds.

Call Back will be cancelled if the Call Back feature is completed or failed to connect the call after 45 minutes.

Analogue and ISDN-Phones

Storing and Dialling Phonebook Numbers (Central Dialling Memory)

You can centrally store up to 1000 important external phone numbers and affiliated names in the telephone system. These telephone numbers can be retrieved from any analogue phone.



As well as normal phone numbers you can also store code digit procedures in your phonebook using the ***** and **#** keys. This means you can then use all the procedures on telephones which do not support the ***** and **#** keys.

Numbers in the Phone Book can be retrieved alphabetical, numerical or as vanity dial. Vanity dialling: With the Vanity dialling you do not have to remember the location of the speed dial number in the phone book. Just enter the name.





Example: Select entries in the phone book with

Dellmann	D ⁰ ₃ E ⁰ ₃ L ⁰ ₅
Diener	D ⁰ ₃ I ⁰ ₄
Edner	E ⁰ ₃ D ⁰ ₃ N ⁰ ₆ E ⁰ ₃
Fenlo	F ⁰ ₃ E ⁰ ₃ N ⁰ ₆ L ⁰ ₅

Phonebook (Numeric retrieval)

	→	* 3	→	0 0 0 to	9 9 9	→	
Lift receiver		Enter the phonebook code		Enter the phonebook destination 0 0 0 to 9 9 9 ; the stored phone number is dialled.			Conduct the call

Phonebook (Vanity retrieval)

	→	* 3 * 				
Lift the receiver		Start Vanity dialling	Enter name	External dialling tone if name has been clearly identified. The destination is dialled automatically after 4 seconds or immediately after entering an # .	Ring tone, subscriber is called	Hold conversation

Analogue and ISDN-Phones

Notes

You can set in the configuration of the system, if extensions which have no line access can dial numbers from the phonebook.

If your extension is barred, then you cannot dial numbers from the phonebook which fall into this category. You will hear error tone.

If a number has been stored without a name in the phone book, then the only method of retrieval will be numeric.



If the Phonebook location has no entry, you will hear an error tone.

Phonebook - storing a number



Programming mode must be started by entering :  → *705  

 → *711 → 000 bis 999 →



Lift receiver Enter the phonebook programming code Enter the location of the number to store

 → #  → 

Enter an external phone number without „9“ (outside line seizure) Confirm input Acknowledgement tone Replace receiver



Continue programming or end programming mode by entering:  → *700  

Phonebook - clearing a phone number

Programming mode must be started by entering :  → *705  

 → *710 → 000 bis 999

Lift receiver Enter the code for clearing and entry Enter the location of the number to clear

 → 

Acknowledgement tone Replace receiver

Continue programming or end programming mode by entering:  → *700  

Analogue and ISDN-Phones

Telephone lock - direct call (baby call)

You can protect your telephone against unauthorised use by locking it.

If your telephone is locked, you can:

-only call extensions

-accept all incoming calls and transfer them to extensions

-only call the stored emergency and direct call phone number.

In addition you can use automatic dialling (Hotline) but this feature must have been enabled before locking your phone. If you have programmed a PIN number for your phone, then this must be entered to either lock or unlock your phone.

Locking your Phone



Unlocking your Phone

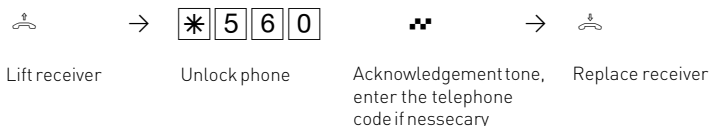

Notes

Enter telephone PIN?

If you hear the acknowledgment tone after entering the code, no telephone code has been programmed for your telephone. There is no need to enter the telephone code. If you hear the error tone, the last input was wrong. Begin the input again.

If you do not hear any tone after making -inputs, a telephone code has been programmed for your telephone.

Enter the 4-digit telephone PIN. If the code is correct, you will hear the acknowledgment tone. If the PIN is wrong, you will hear the error tone. Replace the receiver and begin the complete input again with the right telephone PIN.

ISDN-Phones - Looking via * -procedure is not possible.

Analogue and ISDN-Phones

Programming Telephone Lock (PIN)

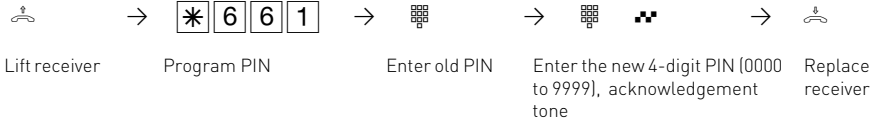

Clearing Telephone Lock (PIN)

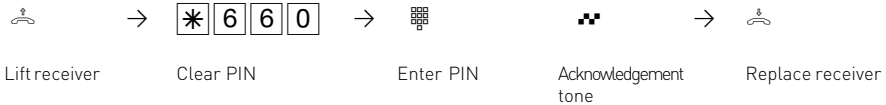

Direct call (Baby call)

The Telephone is locked. When any button is pressed, the number stored as the direct number is dialled. The emergency call/direct call function has priority over all outside connections in progress. If necessary a call in progress will be force released in order that the emergency call can be set up.

Store a Direct Call Number

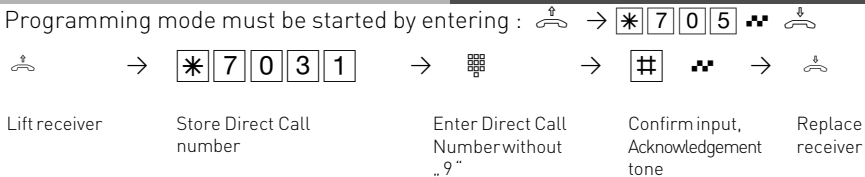

Continue programming or end programming mode by entering: → *** 7 0 0**

Clear the Direct Call Number



Continue programming or end programming mode by entering: → *** 7 0 0**

Analogue and ISDN-Phones

Notes

The „Telephone Lock- Direct Call (baby call)“ feature cannot be used on ISDN telephones.

Timer Functions

The telephone system has timers that can be used to activate certain functions at specific times. The following features can be time controlled:

- AIS announcement text
- Busy-on-busy
- Call barring
- Call Distributiun by Day / Night
- Call Distributiun Door
- Call Distributiun Forwarding
- Diversion
- Do not disturb
- Hunt group mode
- Phone lock
- Phonebook Macro
- TAM

You can assign one or more functions to any timer. Up to 10 functions can be switched by timers. The timers can only be programmed in the “TK-Suite ”program.

Timers can be switched on or off manually from any phone for example the Office closes early and therefore night service needs to be switched on prior to the set time. Several timers can be grouped into one so that they can be activated simultaneously.

Activating/deactivating Timers

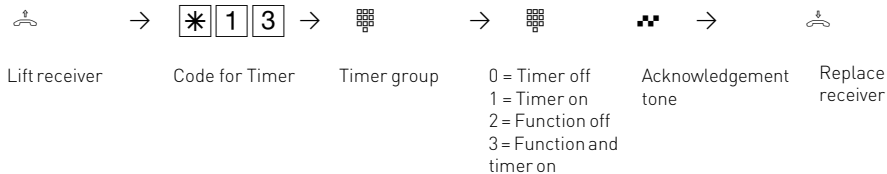

Analogue and ISDN-Phones

Doorphone Diversion to External Number

You can divert your doorphone to any external number, including mobile, if you want to be contactable by a visitor even though you are not in the building. Regardless of the set diversion the internal extension will still ring and can also be answered by the extension.

If you divert to an ISDN terminal capable to display the calling number, then the identification of a doorphone call is possible and you can answer accordingly.

You can also enable or disable a programmed doorphone diversion from any external telephone. For instruction on how to do this remotely please refer to the user manual for analogue phones section 'Diverting a doorphone to an external number.'

Programming Doorphone Diversion

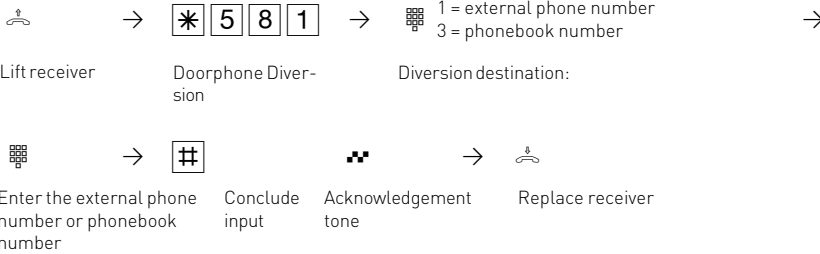

Doorphone Diversion off



Analogue and ISDN-Phones

Doorphone Diversion on / off from external

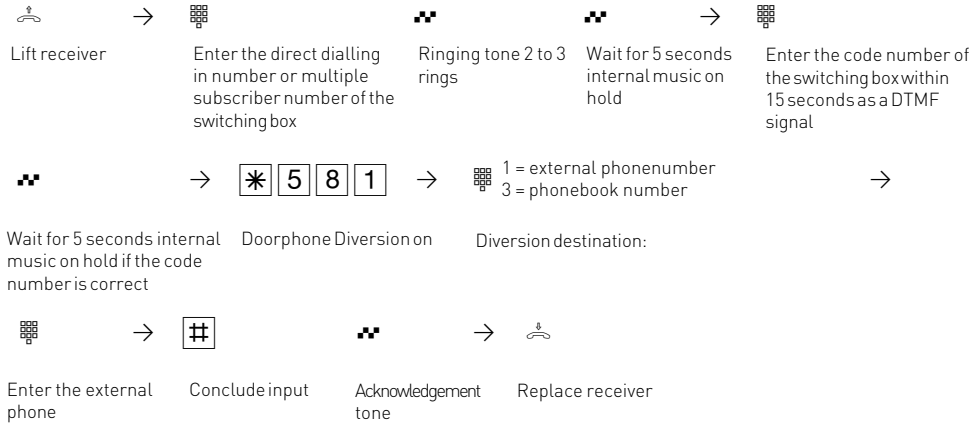

Notes

The external number will ring for 30 seconds, after which the call is cancelled. The external Doorcall will be disconnected after 10 minutes. The door opener cannot be activated from a diverted call.

Switching over the door call variant

Which phones are to ring when the bell push is pressed are set with the doorphone setting variant 1 and 2, day- night service call distribution setting. The doorphone class of service can be switched from any telephone, internal or external. If you change this from an external number then you have to dial the switch box which can be accessed via a DDI number on a PTP or a MSN number for a PTMP line. If Night Service has been switched off, then Day Service is enabled.

Analogue and ISDN-Phones

Doorphone Night Service on / off

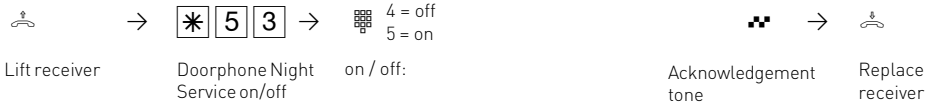

Doorphone Night Service on / off from external

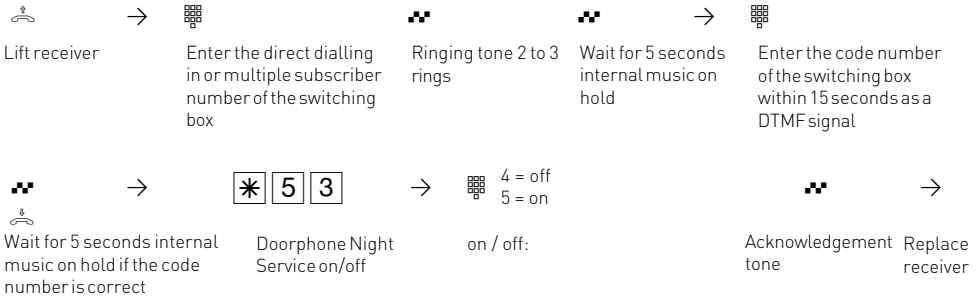

Notes

If the selection „ext. all“ is set up when Night Service is switched on/off, Night Service is switched on/off at the same time.

Analogue and ISDN-Phones

Operating the Doorphone and Door opener

You can speak to someone at the door if your system has a doorphone (TFE) connected to it. Your phone will ring with a distinctive ringing sequence if a visitor presses the bell push at the doorphone.

The doorphone will be answered as soon as you lift the receiver on your phone. You also can activate the door opener from your phone whilst speaking to the doorphone. You can also Call Pick Up a doorphone call that rings at another extension. Your extension will be busy during the connection to the doorphone.

Answering a Doorphone Call



Calling the Doorphone / Picking Up a Doorphone Call



Operating the Door opener during a call

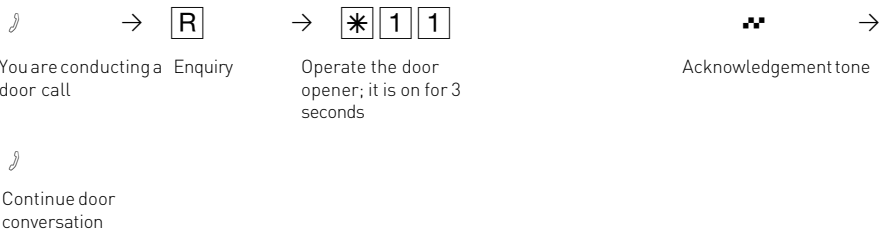

Operating the Door opener directly



Analogue and ISDN-Phones

Operating the Door opener during an external conversation

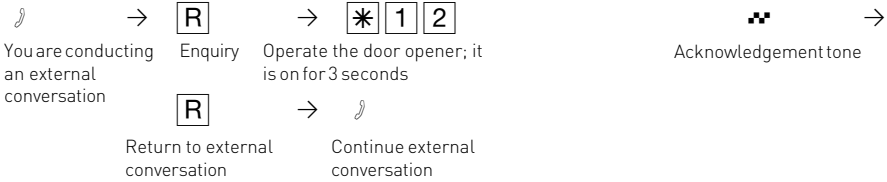

Communicating a caller's phone number on the internal S0 bus

When an external ISDN subscriber calls, the telephone system is transmitting the caller's phone number to the called ISDN terminal (ISDN telephone or PC with an ISDN card) on the internal S0 bus. On the ISDN terminal, you can specify that the telephone system adds a „9“ for seizing an outside line before the communicated phone number. If you have stored a phone number in this way, you can dial it automatically from the call list of an ISDN telephone or an ISDN PC.

Outside line seizure - „9“ on / off

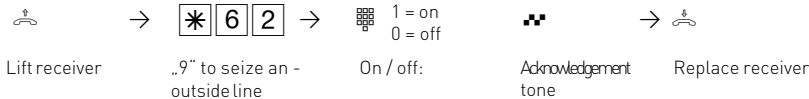

Notes

This setting is only recommended if you have set „outside line seizure 9“ on the ISDN terminal. This setting is not necessary if you have set „spontaneous outside line seizure with internal“ or „spontaneous outside line seizure“ on the ISDN terminal.

Sending CLIP or COLP

The telephone system transmits your phone number to another ISDN subscriber before the connection is established (default setting of the system). Two types of settings are available within the ISDN network:

Forwarding the telephone number to the called party (CLIP = Connected Line Identification Presentation)

Your telephone number will be forwarded to the subscriber you are calling.

Forwarding the telephone number to the calling party (COLP = Connected Line Presentation)

Your telephone number is forwarded to the subscriber calling you. This ISDN feature will have to be ordered from your network provider.

Analogue and ISDN-Phones

Setting COLP to on / off

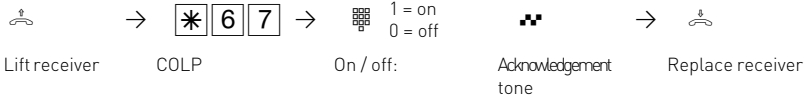

Setting CLIP to on / off

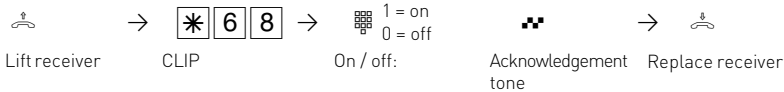

Notes

Your complete number will be send to the network consisting of STD Code and DDI number or STD Code and MSN number, depending if the line is for system access (PTP) or standard access (PTMP). You must transmit a valid number belonging to you. If you transmit a number which is outside your allocated range then the telephone exchange will automatically replace this number with the main number allocated to the ISDN 2 e circuit. Call charges cannot be billed by Network provider under seperate MSN numbers Therefore change to the following.

To transmit a specific MSN number back to the exchange dial the following without 9
*00 -MSN-# -external phone number.

Diversion from - Divert other Extensions

You can divert other extensions to your own which may momentarily not be staffed. After the diversion is enabled, the diverted phone will not ring for any further calls. Calls can still be made normally from the diverted extension. A special dial tone will remind the diverted extension that a feature is enabled.

Diversion from - on

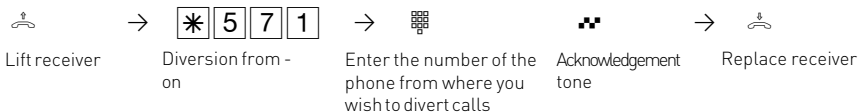

Diversion from - off



Analogue and ISDN-Phones

Notes

Calls can only be diverted once. Calls diverted to you are ringing your extension only even if you have set a 'Diversion to' on your phone.
A "Diversion from" a phone where the Do Not Disturb feature has been set to your extension is possible.
Returned Calls, Wake Up and Appointment calls cannot be diverted.
Users of radio cells (base station with cordless telephones) cannot activate diversion.

Diversion to - diverting calls to another phone

Diversion via the Phone System

You are able to divert all calls for any phone either to another extension or via the second B channel to any number worldwide. Following options are available:

- Divert all Calls
- Divert when Busy
- Divert no Answer (after 15 seconds)

The diversion to an external number can also be set up remotely from any number worldwide.

After the diversion is enabled, the diverted phone will not ring for any further calls. Calls can still be made normally from the diverted extension. A special dial tone will remind the diverted extension that a feature is enabled.

Analogue and ISDN-Phones

Diversion To - on

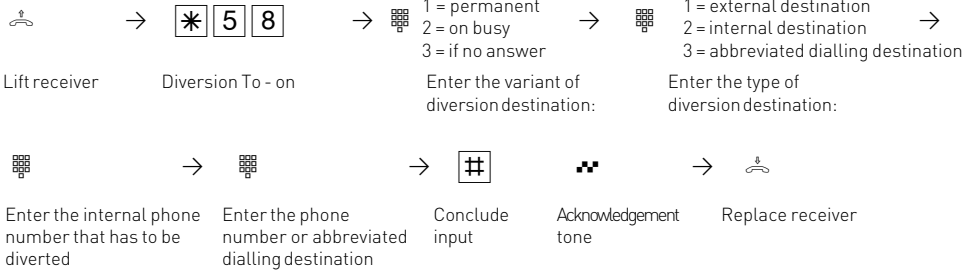

Diversion To - off

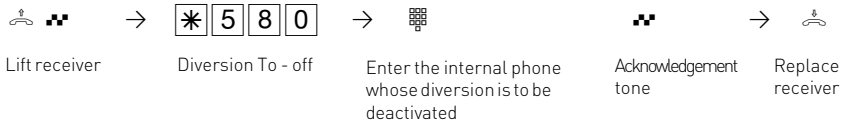

Configuring Diversion to from external (example: diversion to - on)

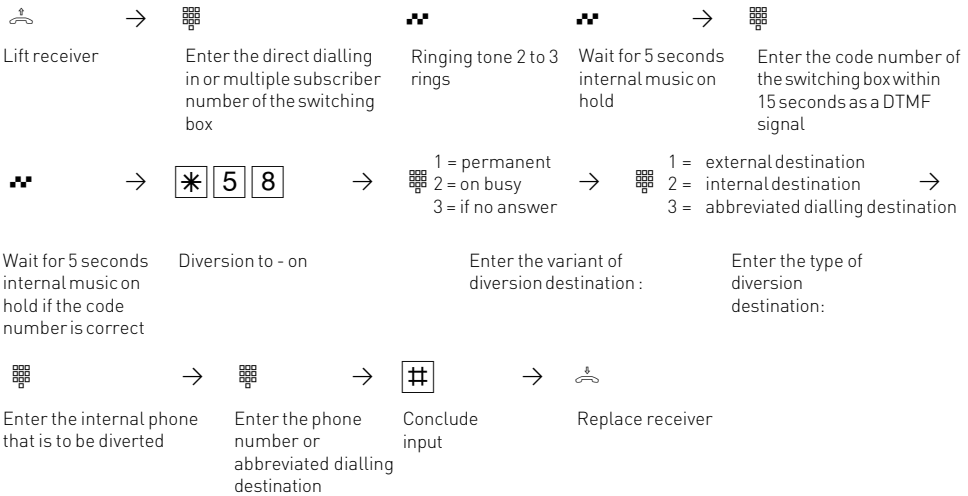

Analogue and ISDN-Phones

Notes

A diversion will not be carried out if the call to be diverted has already being once diverted. Diversions to an extension where Do Not Disturb is set are not possible. Returned calls, Alarm and Appointment Calls cannot be diverted.

Diversion to external subscriber:

A line must be available for diversions to an outside number.

The diverting extension must have the correct line access level set in order to establish a diversion to an outside number. You will have to pay call charges for diverted calls.

Call Forwarding

Diversion via the public switched telephone network. Call forwarding can only be setup if this feature has been ordered from your telephone exchange. If call forward is carried out on a Point to Point (PTP) connection then the entire line including all DDI's are forwarded. To forward individual DDI numbers via the telephone exchange and without busying your second B Channel you must have the feature PARTIAL RE-ROUTING enabled in the program of the telephone system.

Using this feature on a Point to Multipoint (PTMP) then partial re-routed does not need to be set as each individual MSN can be diverted. When using a call forwarding button on your phone you can select the line to be forwarded.

Call forwarding can also be programmed remotely from any telephone who can dial your system. For instructions on how to activate call forwarding remotely, please refer to your user manual for analogue extensions under the heading 'Diverting to....' A destination telephone number must have been programmed if you want to switch on or off call forwarding via a feature button. The following types of call forward are available.

- Forward all calls
- Forward on busy
- Forward on no reply

Analogue and ISDN-Phones

Permanent call forwarding - on

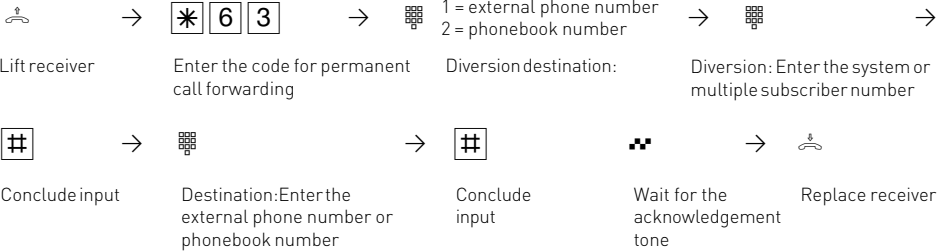

Call forwarding on busy - on

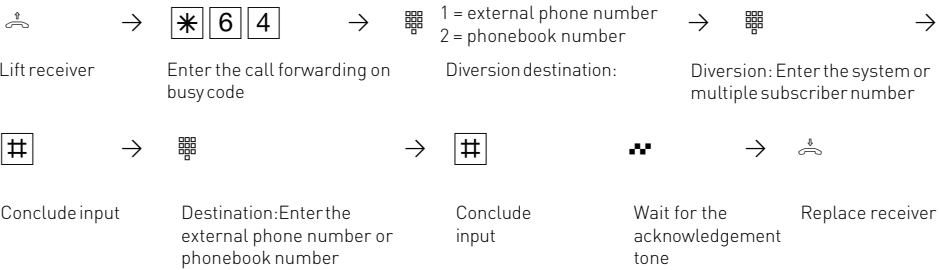

Call forwarding if no answer - on

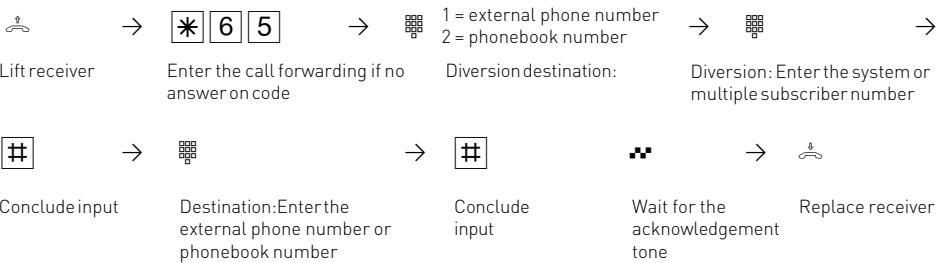

Call forwarding - off

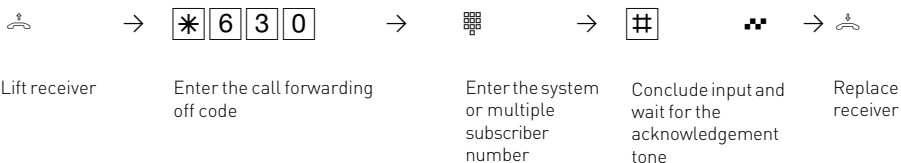

Analogue and ISDN-Phones

Call forwarding - clear

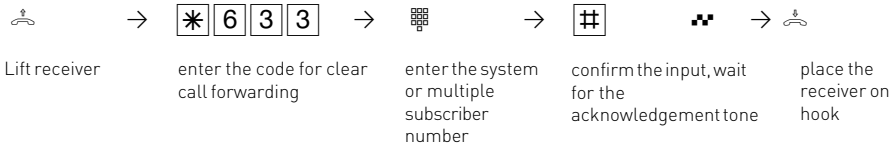

Notes

You can only program a call forwarding destination if this has not already being forwarded. Outgoing calls are unaffected if call forwarding has been set. You will hear a special dial tone from the telephone exchange whilst this feature is enabled.

Configuring Call forwarding from external

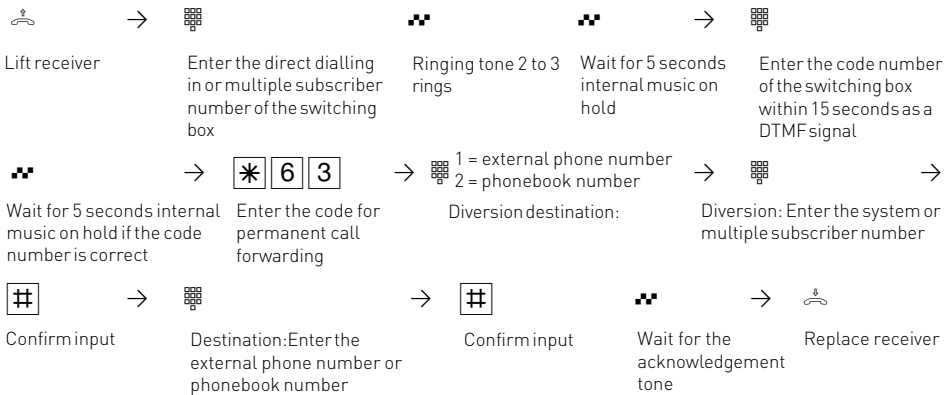

Notes

When call forwarding is on, you hear the special dial tone of the ISDN exchange when you seize the outside line.

When you have configured call forwarding in the exchange, please note that up to a minute may pass between setting up and the acknowledgement tone. Do not replace the receiver during this time.

Call forwarding from an external location: please note that you can confirm inputs by pressing the **[R]** key instead of the **[#]** key.

Analogue and ISDN-Phones

Display Call Charges on an analogue phone

On an analogue phone, you only can display call charges if the phone has a meter. To display call charges, you must activate communication of the charge pulses for your phone on your phone.

If you have requested the „communication of call charges during and at the end of the connection“ feature from your network carrier, your phone continuously displays the call charges during a connection.

You can display the charges of your last connection that are stored in the telephone system at any time. To do this, it suffices if you have requested the „communication of connection charges at the end of the connection“ feature from your network carrier.

Communication of charge pulses on / off

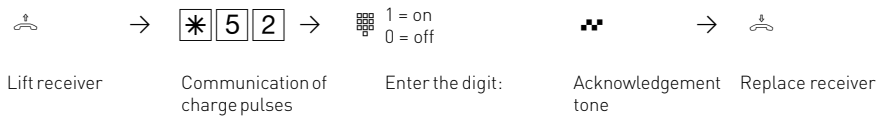

Display charges of the last connection

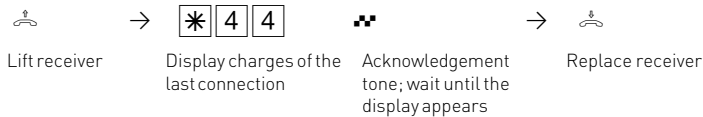

Notes

If you wish to display the charges of the last connection by entering , please note that your telephone's totalizer may total up the costs of the last connection.

For technical reasons, the data on the network carrier's invoice may deviate from the total call charges displayed by the telephone system. The charge units counter in the network carrier's exchange is always binding.

IMPORTANT NOTE:

On using analogue lines, call charges cannot be displayed or calculated!

Analogue and ISDN-Phones

Telephone Answering Machine (TAM)

An AGFEO ST 30 system phone can be expanded with a 'A Modul 30' telephone answering machine. The answering machine can be switched on or off from any extension or remotely from any telephone number. The module can be recorded with two messages, one for normal operation and one for announcement only mode.

If the ST 30 is programmed with a primary and secondary extension number then the answering machine can answer each number with a different message in turn. (Like having two answering machines) The two extension numbers will work totally independent from each other and each machine can be switched on or off as required.

Switch on / off (from another extension)

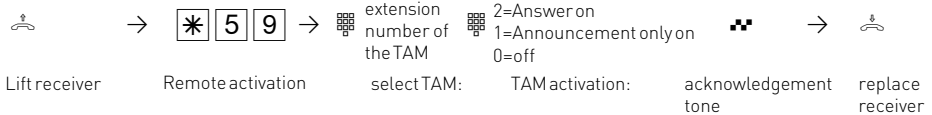

CLIP - display caller's phone number

On analogue telephones which support the CLIP feature, you will see who is calling before you lift the receiver. For external calls, the caller's number and the date/time are displayed. The name is displayed additionally for internal calls. You have to set whether or not you want to use the CLIP function on the telephone.

Switching on CLIP

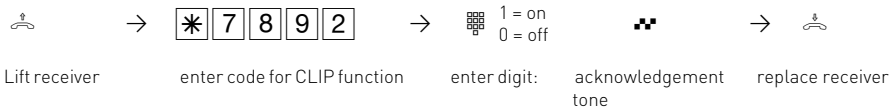

Analogue and ISDN-Phones

Extended CLIP functions

You also have the possibility of using various options of the phone number transmission which you can switch on for the whole system with a code number procedure.

- Clip off
- display phone numbers only
- display the name from the phone book (if available)
- display date and time as well
- in the case of an internal diversion, display for which connection the call was intended (this is only of interest for answering machines with a mailbox function, the answering machine can then activate the appropriate mailbox directly).

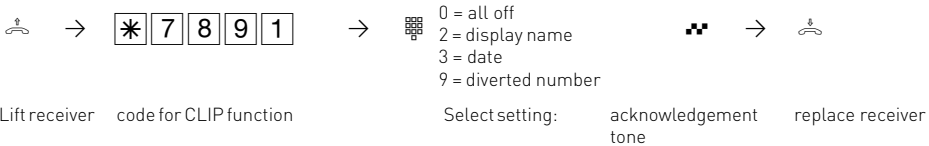

Groups

You are part of a group if your extension number has been allocated to a group number. (please refer to TK Suite).

You can log in or out of the group with the function.

The sequence of the call distribution is important (for even call distribution within a hotline for example) and will not change if a group member will log in or out of the group. A maximum of up to 20 groups can be formed and every extension may be a member of every group.

Log In / Log Out

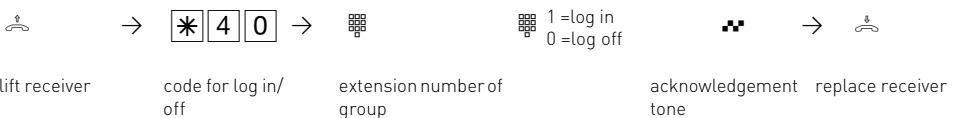

The call sequence as defined with TK Suite will not change.

Analogue and ISDN-Phones

Callthrough

You may use the MSN of your switchbox as low-cost priority number for your mobile phone (ask your cellular provider).





When calling your switchbox from your mobile, you can use abbreviated dialling from your system's telephonebook. The telecommunication system then calls the subscriber you have chosen on the second B-channel.

It is of a great advantage to store your mobile phone's number in the system, so you don't need to input the system PIN.



After gaining access to the telecommunications system via the switchbox you can operate every controllable function via **[*]** procedure remotely.

Entering/ clearing your mobile phone number





Programming mode must be started by entering :  → **[*][7][0][5]**  

 → **[*][7][7][9]** →  → **[#]**  → 

Lift receiver code mobile phone number enter mobile phone number confirm input, Clear: continue with making an acknowledgement tone replace receiver

Continue programming or end programming mode by entering:  → **[*][7][0][0]**  

Callthrough

 →   → **[*][3]** → **[0][0][0]** to **[9][9][9]** → 

Lift receiver enter number of switch box (your callthrough number), acknowledgement tone of the telecommunications system, when mobile phone number has been identified code for phone book Enter destination from phone book, the stored number is dialled hold conversation

Notes

If you hear the busy tone instead of the ringing tone after dialling the destination, either the subscriber or the 2nd B-channel is busy. The busy tone is switched off after about 10 seconds and you can select another phone book entry from **[*][3]**.

Analogue and ISDN-Phones

Wake Up Call – Repeated Appointment Call

You can place a Wake Up Call from your phone. The wake up call will be completed once you lift and replace the receiver. The Wake up call will ring your extension even if do not disturb is set.

Switch off Wake Up Call

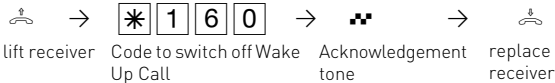

Switch on Wake Up Call

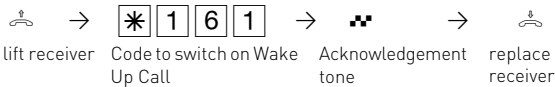

Receiving a Wake Up Call - stop Wake Up Call

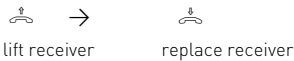

Receiving a Wake Up Call - activate snooze function

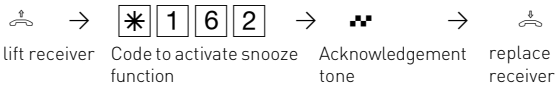

After completion of the procedure 'Continue Wake up call' the phone will ring every 10 minutes for a one hour period.

Enter Wake Up time

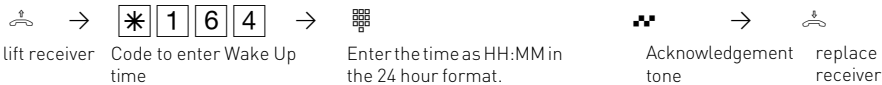

Delete Wake Up time



Analogue and ISDN-Phones

Set Wake Up Call days from Analogue or ISDN Telephones

You can specify on which days the alarm will be triggered on your analogue or ISDN telephone after you have entered an alarm time



* 1 6 6



Enter digits, according to the list below

#

0 = all off

8 = Monday to Friday

9 = Monday to Sunday

1..7 = Monday..Sunday

You can enter several days in sequence.

Integrated AIS-Module

The integrated AIS-Module adds an Audio Information System to your system. The AIS-Module will enable you to integrate individual messages and Music on Hold into the system. You may activate an announcement for up to two callers simultaneously to be played before the call is answered, or only if the operator or extension is busy.

The "Message prior to answering" function can be used for 2 external lines, and can be configured to provide the caller first with a message prior to connecting, or to deliver the announcement in the event of a busy user or group.

Individual Music on Hold can be played using the AIS Configurator.

In default the AIS-Module has pre-recorded with Music on Hold and announcements.

The AIS-Module can hold up to 70 minutes of audio files. In default 11 Minutes are used with pre-recorded messages. Audio files may be used to play information, promotional messages or music.

For musical recordings please observe relevant copyright laws!

With the AIS Configurator you can select individual .wav files or converted MP3 files and assign them to different message types, for example, greeting, music-on-hold, door, sensor and wakeup alarm. You can create these .wav files yourself or obtain them from commercial sources [see standard tunes]. Please note, that these wavefiles must use standard PCM format, 8 or 16 Bit, mono or stereo in sampling rates from 6 to 48 KHZ. These files have to be audiofiles without additional headers (copyprotection).

Wake-up alarm times can be set from individual telephones by using the keypad. At a specified time you can receive a call with a message, for example "This is your wake-up call. The time is ..."

If a door contact or other sensor is connected to the telephone system then an internal or external call can be initiated to a preset telephone number, once the sensor has been triggered, and deliver a spoken message.

You may assign a message to such calls, for example "Sensor door one has been activated." Calls from a door phone may be signalled by playing different tunes, using audio files.

Operating

After you have installed the AIS module and have programmed TK Suite Set, start the AIS Configurator. Click on the "Read system" button, the AIS data is read out from the phone system. Please make sure that the AIS Configurator links to the system via the X.31 protocol. If you are using TK Suite Basic with a permanent X.31 connection, you have to close TK Suite Server in order to use the AIS Configurator.

The AIS Configurator will offer various messages as well as editing fields.

In the Profile pane, you can:

- Load an existing AIS configuration
- Save a new AIS configuration
- Create a new configuration

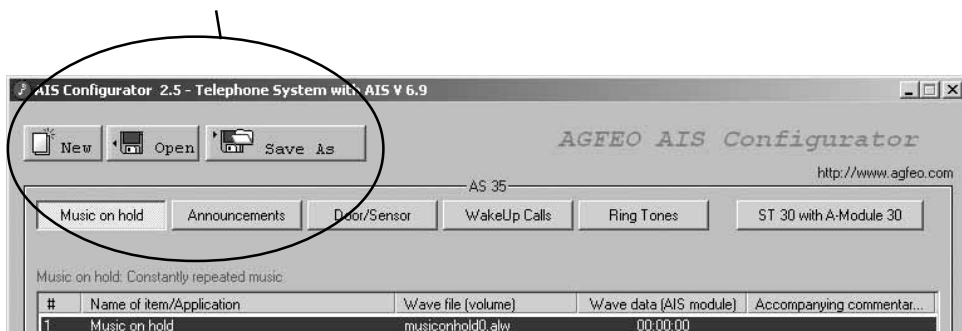

Operating

If you click with the right hand mouse onto an entry, a context menu will open.

In this menu you may select the following:

- select wave file on PC, to be allocated to the AIS Module
- listen to selected WAV file
- delete the selected entry
- enter or delete a comment
- send selected wave file to the system
- delete a wave file in the system
- read out a wave file from the system
- check a wave file in the AIS Module

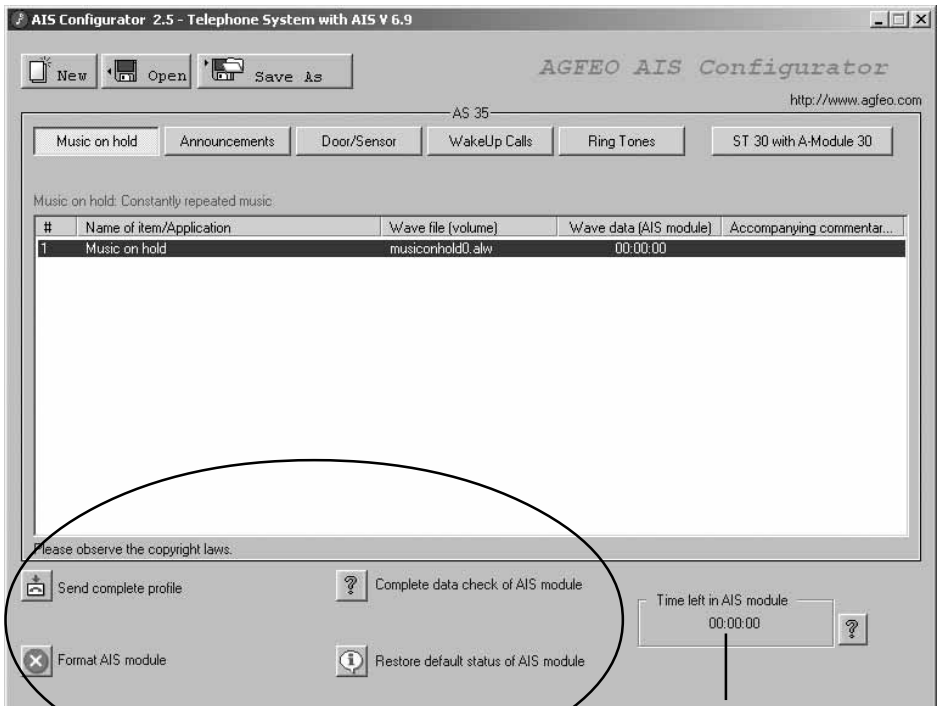

This line displays the available AIS system storage in seconds

In the Communication pane you can:

Select a .wav file on your PC (an index must be highlighted for this)

Send a new AIS configuration to the system

Delete an existing AIS configuration in the TK system.

Read out an AIS configuration from the system.

You can change a comment in the message pane by double-clicking with the left mouse key which activates the editing mode.

Loading .wav files into the TK system can be done either using the internal S0 bus.

Transferring Messages and Music-on-Hold

Music on Hold is automatically integrated into your TK system with the AIS-Module. The Music on Hold can be replaced at any time using audio files. This is how you do it.

Music on Hold (MoH)

Audio files allow you to create pleasant on-hold music to be played while a caller is on hold or is transferred to another extension.

Changing Music on Hold

Click on the Music on Hold button The following appears in the input screen:

Index	File name	Comment
Music on hold1	Name	Comment

Highlight the line Music on hold1.

You can listen to available .wav files using the "Listen to .wav file."

The "Select .wav file" button allows you to select .wav files stored on your PC and transfer them to a tagged location using the "Open" function.

By clicking on the "Change comment" button, you can enter a comment or a title; the change is applied using the ENTER key.

When you change a comment, you must first highlight the field (line) you wish to change.

Please note:

Music on Hold must be activated in the TK Suite Set configuration program in the pane "Additional settings" under "Music on Hold."

Please follow current copyright laws when using music selections.

Messages Greetings

The greeting announcement is played to external callers before they are connected to one of the groups you have defined. For example, the greeting might be used for marketing purposes. As soon as an external call is put in a "Message prior to answering" queue, a seasonal message might be played, for example, "Winter is coming up. Time to think about snow tyres." You can also define whether calls for the group always hear the message, or only if all extensions within the group are busy. You may also specify whether the greeting is played in its entirety before the call is answered, or whether the call can be answered during the message playback. If group members are called according to your call distribution, a call can be picked up during the announcement.

Applying greeting messages

Clicked on the button "Greeting message." The following appears in the input screen:

Index	File name	Comment
Message 1	Name	Comment
Message 2	Name	Comment
.....to	:	:
Message 10	Name	Comment

Highlight Line 1, for example.

The "Listen to .wav file" button allows you to listen to the .wav file (if available).

The "Select .wav file" button allows you to select .wav files stored on your PC and transfer them

to a tagged location using the "Open" function.

By double-clicking on a line (e.g., "Message 1") you change to edit mode, allowing you to change

the comment. "ENTER" applies this comment.

On-Hold-Message

When an external caller has received the greeting and has been transferred to the "Message prior to answering Group," the extensions are called according to their notification type.

During

this ringing phase, you may specify whether the external caller receives an on-hold message (e.g., "Your call is being transferred") or hears ringing tone.

Applying an on-hold message:

Follow the same procedure as for "Applying greetings." Just click on the "On-hold message"

button.

Wake-Up Alarm Message

Each telephone system extension may set an individual wake-up alarm time. At the specified time, the telephone rings and a pre-recorded message is played.

If you use the AIS Configurator, two sample alarm messages are provided as examples.

Alarm 1 - Announcement before the time This is your wake-up call. It is xx o'clock.

Alarm 2 - Announcement after the time Have a nice day

Between the messages for Alarm 1 and Alarm 2, the current time is announced. You may, however, provide your own announcements for Alarms 1 and 2. These messages are automatically used for a wake-up call.

Applying the Wake-up alarm announcement

Follow the same procedure as for "Applying greetings." Then just click on the "Wake-up alarm message 1 / Wake-up alarm message 2" button.

Time

As described above, the current time is automatically announced between Alarm Message 1 and Alarm Message 2.

If you create your own wake-up Alarm Message, the time is announced using the stored system voice.

If you would rather use a different voice, you may record the individual times using .wav files.

Applying the current time

Follow the same procedure as for "Applying greetings." Just click on the "Time" button.

Settings in TK Suite Configurator

A few additional settings in the TK Suite Set configuration must be adjusted to allow you to use the AIS module and .wav files in the AIS configuration. These are described below.

Music on Hold

The following pane is on the page "Special functions - additional settings:" On-hold music (Music on Hold) with the setting options:

Off (MoH is turned off)

Internal Melody (The AIS module MoH is used)

External source (MoH relies on an external source, such as a CD player)

Select the desired MoH type by first by clicking on the type, and then by clicking on the "Send" icon.

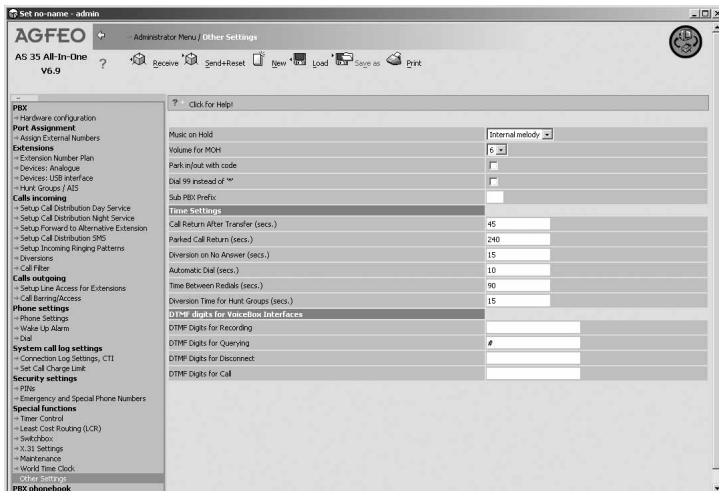

Greeting / On-Hold-Message

Various settings can be adjusted in the configuration page "Internal Numbers - Define Groups." The AIS -Module allows a message to be played before the call can be answered. A message can be played for up to two callers simultaneously. You can also change the settings for two group numbers.

„Message before Answered by Group“

Open the configuration page in the TK Suite Set Configurator "Internal Numbers – Define Groups" and set the Hunt Group number with its extensions, the call mode and ringing for group members.

Once you have established a Hunt Group number with extensions, then the following symbols will appear above the members of the group:

A) By clicking on this button, you will see all extensions who are a member of a group.

B) By clicking on this button you may rearrange the ringing order of the selected extensions. This is important in the event that a member of the group logs out of the group. Once the extension has logged in again, the old position in the group is resumed.

C) By clicking on this button, selected extension may log in or out of the group.

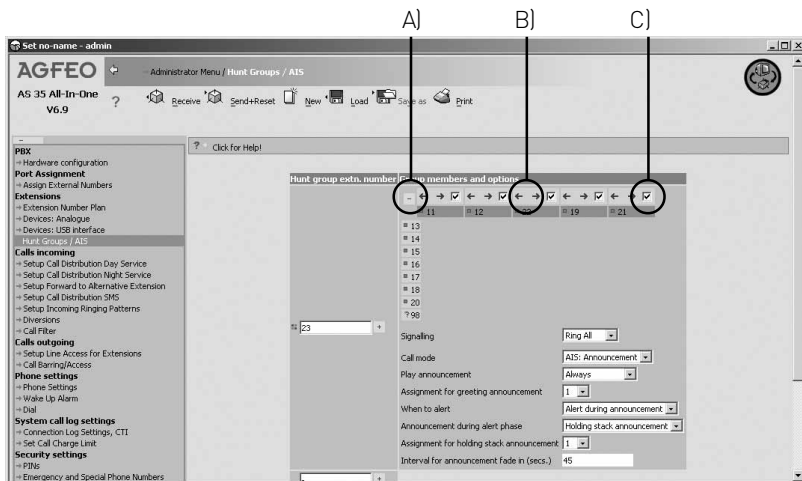

Extension / Group Ringing

In the drop down list you can set the following extension ringing.

Ring all: an incoming call will ring all extensions simultaneously.

Fixed Port: Ringing will always start at the first extension within the group. If the call is not answered then it will go to the next programmed extension within the group. The call will remain ringing at the last programmed extension if no one has answered the call.

Sequential: ringing will always start with the first entry in the group. If the call is not answered then the next extension in the group is added to the already ringing one. This pattern will continue until all extensions in the group are ringing. Ultimately all extensions will ring until the call is answered.

Circular: This means that ringing will start with the first extension in the group. If the call is not answered then it will go to the next extension within the group. If the call remains unanswered at the last extension, then it will start at the beginning of the group again.

Signalling

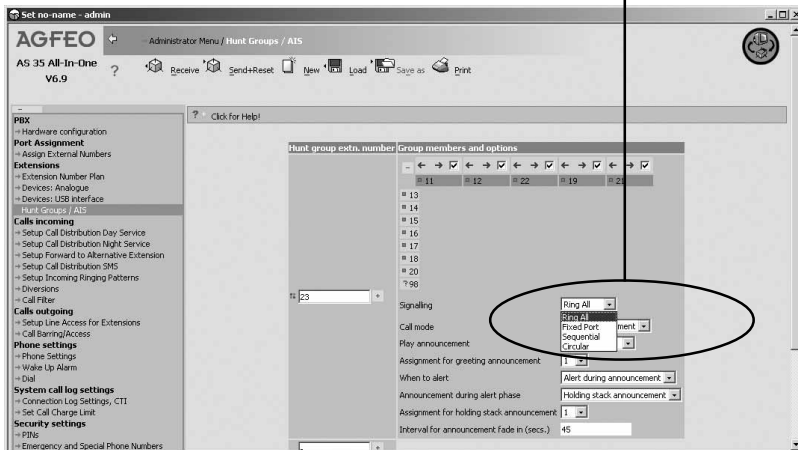

Call Mode

In the setting Call Mode you can select how a call should be answered, ie by the AIS-Module. As soon as you make this selection from the drop down list, further options will be offered.

Play Message

Under "Play message" you can specify whether an external call to a hunt group number is

- "Always" answered automatically with the greeting or
- "Only when the group is busy."

Select the setting.

Message and Ring Sequence

On an incoming call, the caller will receive the announcement as set in play message. You now can select if the hunt group should ring:

- after the announcement-

The caller will hear the announcement to the end before the hunt group is rung.

- or-
- during announcement-

The caller will hear the announcement but at the same time the hunt group is rung. If a member of the hunt group answers the call then the announcement will stop. Select your setting.

Announcement during Ringing

After a caller has listened to the recording and the hunt group is being rung you may select if the caller receives a

- Ringing Tone

or

- a reassuring message, which can be a spoken message with background music, such as 'Please hold your call is being transferred' or 'Your call is important to us etc.

Please select the type required by clicking on it.

Assignment of Message

There are several greeting messages stored in the AIS Configurator under "Messages." These stored announcements have index numbers (1-10) as well as a comment for easy identification. Select the desired message by clicking on it.

Assigning On-Hold-Messages

Under "Messages," various on hold messages are stored in the AIS Configurator. These stored announcements have index numbers (1-10) as well as a comment for easy identification. Select the desired message by clicking on it.

Door-Phone-Messages

Depending on the basic configuration of your telephone system, there are 2 contact / sensor inputs in the configuration page "Doors, Relays and Sensors."

The following settings can be configured:

Operation type:

You can set the operation type "Door" by clicking on it.

Once you have set this operation type, various configuration options for the door are provided in the Option box.

Internal calling number for door: = Extension number for the door

Specify a free internal calling number for the door. = Select a free extension number for the door.

Call Distribution Day Service

Select the extension number which should ring when the door bell is pressed. Also tick the box to activate this setting.

Call Distribution Night Service

Select the extension number which should ring when the door bell is pressed. Also tick the box to activate the night service setting.

Set Up Incoming Ringing Patterns

You can assign a special ringing sequence to the door phone. In this way a door phone call will be easily identifiable.

Door / sensor message: = Door Sensor Message

There are several messages stored in the AIS Configurator under "Messages." These are listed by an index number. Select the desired message ("1" corresponds to the door / sensor message with the index number 1 in the AIS Configurator) by clicking on it.

Night is active:

By clicking on this button you can activate this setting for Night Service.

If this setting is active, then a visitor at the door will receive a recorded message after the bell push is pressed. Extension which are set for Call Distribution 1 Day, or Call Distribution 2 Night will ring when the Bell Push is pressed.

External call:

Under the external call option, you can enter an external number to be called when the someone rings the door bell.

External call:

The external call can be activated / deactivated by clicking on the button.

Record Messages via ST 30

ST 30

It is possible to record all texts from the System Phone.

Enter programming mode:

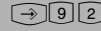

Select the type of text you want to record.

- 1= Door / Sensor Announcement
- 2= Announcement before Answer
- 3= Bell Push Announcement
- 4= Wake Up Announcement



Select announcement type, you can listen to this by pressing "OK".



Press "OK" again if you want to re-record the announcement.



AGFEO has obtained Copyright Free Music and messages from

Ihr Image ist unsere Aufgabe
Corporate music

Schauenburgerstraße 116

24118 Kiel

Tel.: +49 (431) 5606370

Fax: +49 (431) 5606371

info@on-hold.de

<http://www.on-hold.de>

Programming your System

Programming your System

Programming via PC

After installation, your telephone system is prepared to enable you to immediately conduct telephone calls in the usual fashion and to directly benefit from further advantages of the system. However, the system allows diverse programming possibilities so you can configure it to suit your very own personal leads. Without needing to have any knowledge of a programming language, you can program the telephone system from a PC connected via the RS 232 C interface or from a PC with an ISDN card connected via the internal S0 bus. Easily understandable menus guide you through the configuration program. The configuration software is on the included CD ROM.

System requirements

- IBM- or compatible PC with hard disk and CD ROM drive
- Pentium II 233 MHz or higher
- at least 64 MB RAM
- Microsoft Windows 98/2000/ME/XP
- RS 232 C- or USB interface

Connecting a PC

Connect the telephone system's RS 232 interface [D-SUB-9 socket] to the PC's COM port. Use a 1:1 V.24 plug socket extension lead for connection. It must not be longer than 3 m.

Start the configuration program.

Configure the telephone system. Your inputs are accepted interactively by menu prompting. After completing configuration, remove the cable from the telephone system

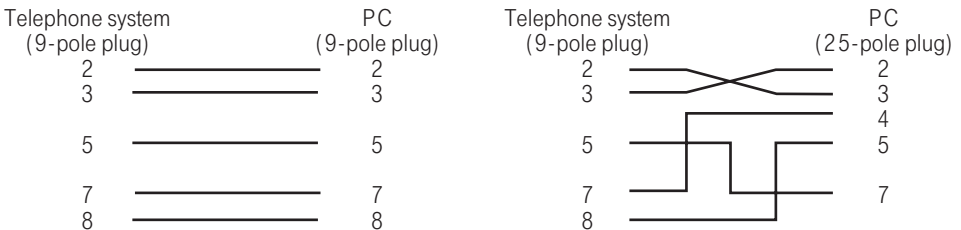





Programming your System

Programming from the system telephone or a/b telephone

After installation, your telephone system is prepared to enable you to immediately conduct telephone calls in the usual fashion and to directly benefit from further advantages of the system. However, the system allows diverse programming possibilities so you can configure it to suit your very own personal needs. You can execute the programming instructions with the  procedure on the system telephone and on the a/b telephone.

General notes on programming from the system telephone

Initiating programming: the individual programming functions can be initiated in two ways: - by pressing  and by entering a program number or initiate programming by pressing , scroll down by pressing  or scroll up by pressing  and select by pressing  (see programming tree).

Pay attention to the display. If the **setup code** is prompted, enter the 4-digit code (see „Protecting functions of the telephone system against unauthorised use“).

The display may show what you are able to enter.

Defined values are embraced in arrows, e.g.: 1 2→3 ←4 5 6 7 (to set the tone ringing volume).

A flashing cursor marks an input location.

To move the cursor to the right: 



To move the cursor to the left: 



Any existing input can be overwritten or can be cleared by pressing .

Confirming inputs:  (input is stored)



Accepting a displayed value without change: 

Clearing inputs:  (clear flashing input)

  Clear specific input)

  Shift key clear (clear complete input)

If you ever hear a beep (error tone), you have pressed a key that is not allowed for the current operating step. Have a look at the display to find out which input is required and try again.

Cancelling programming: press  several times (anything you have not confirmed by pressing  will not be stored).

- Time out: The programming is aborted automatically if you do not press a key for 60 seconds (everything which you have not yet confirmed with  is not saved).

Ending programming:  (all inputs are stored)

If a call arrives while you are programming:

Lift the receiver. Programming is cancelled.

- Everything you have already confirmed by pressing  is stored.

- Everything you have not yet confirmed by pressing  is not stored.

Programming your System

Notes on programming with * - procedures

Programming with the * procedure always covers the steps:
Start programming mode, input and exit programming mode.
When programming, pay attention to the dial tones or dial pulses in the handset. Wait after entering every digit until the digit has been dialed. Only then will you hear the acknowledge tone if your entry is valid or the error tone if your entry is invalid.
Recommendation: Use a DTMF telephone (touch-tone dialing) for faster programming.
You can press the loudspeaker button instead of „Lift handset“ or „Replace handset“ when programming on the system telephone.

Starting the programming mode

To be able to change settings you must first start the programming mode
Lift handset
Start programming mode
acknowledge tone or enter setup code
Replace handset
Enter setup code?
If you hear the acknowledge tone after *705, no setup code is programmed in the telephone system. It is not necessary to enter the setup code.
If you hear the error tone, the last input is wrong. Start the input again from the beginning. If you do not hear any tone after *705, a setup code is programmed in the telephone system.
Enter the setup code in 4 digits. If the code is correct, you will hear the acknowledge tone. If the code is wrong, you will hear the error tone. Replace the handset and start the whole input again from the beginning with the correct setup code.



* 7 0 5



Exiting the programming mode

After you have made all the settings, you exit the programming mode. At the same time you save the new settings. These are retained even in the event of a power failure.
Lifthandset
Exit the programming mode
Acknowledge tone
Replace handset



* 7 0 0



Programming your System

Adjusting the flash time

Analog telephones with tone dialling need a flash key, among others, to transmit calls (R key or Signal key). To adapt the telecommunications system to the different flash times of the telephones you can program the flash time range for your analog extension in the system. You will find the flash time of your telephone in the telephone's technical specifications.

To test whether the set flash time is correct:

- Set up an external call.
- Press the Flash key.
- If you hear the internal dial tone the time is correctly set.
- If the connection is cut the flash time is programmed too short in the system.

Adjusting the flash time for your own extension

Programming mode must be started with

*705!

Lift handset

Code for flash time adjustment Enter code for flash time range

2 = 50 to 200 ms

3 = 50 to 300 ms

4 = 50 to 400 ms

5 = 50 to 500 ms

6 = 50 to 600 ms

Acknowledgement tone

Replace handset

Continue programming or quit programming mode with *700!

Notes

You can adjust the flashtimes for analogue connections of the AS 35, AS 35 All-In-One



*788



Programming your System

Setting the ringer rhythm for incoming external calls

In order to distinguish between calls to different numbers, the phone numbers in the system can be assigned four different ringer rhythms instead of the normal external call ringer. The ringer rhythms are code rings 1 and 2, supplemented by code rings 3 and 4.

Programming mode must be started with

*705!

Lift handset

Code for ringer rhythm setting

Enter number

End input

1 = Code ring 1

2 = Code ring 2

3 = Code ring 3

4 = Code ring 4

0 = External call

Acknowledgement tone

Replace handset

Continue programming or quit

programming mode with *700!



* 7 3 2



Ring rhythms

All ringer rhythms for incoming calls begin with an initial 500 ms pulse, followed by a 2 second pause. This is a technical requirement to allow caller identification (Calling Line Identification Presentation - CLIP). Thereafter the ring can be programmed differently to distinguish between calls to different extension numbers in the system (see diagram).

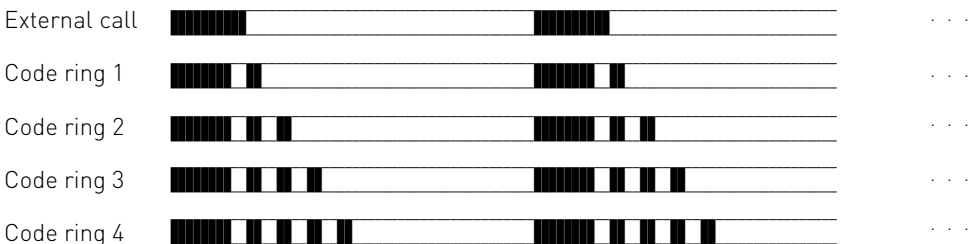

The rings may be different, depending on the terminal equipment in use.

The code calls 3 and 4 are not signalled to analog ports that are set to type „radio cell“.

Programming your System

Variable call times of the TFE's

The call times of the TFE's can be set. You can select the call times freely between 10 and 240 seconds.

This is done by the following code number procedure:

The call time must be entered in 3 digits (e.g. 010 for 10 seconds)

The repetition mode of the call is also adjustable whereby you can choose between a single call sequence and the option of repeating the call sequence up to the end of the call time:

Enter the repetition mode

0: single sequence

1: call sequence repeated up to the end of the call time.



* 7 1 8 6 

* 7 3 8 4 8 

Protecting functions of the telecommunications system against unauthorised use (code numbers)

You can protect some of the functions of your telecommunications system with codes against unauthorised use.

Setup code - normally every subscriber can program.

You can lock all functions reached by  9 or  7 so that these functions can only be used after entering a four-digit code.

You can switch the setup code on and off and change it. The ex-factory code is always 2580, those are the middle keys from top to bottom. The setup code is switched off. You cannot do the setup if you forget your code. Consult your dealer in this case. Only he can reset the code.

Cost code - normally everyone can have the total call costs of all subscribers displayed or cleared. You can protect this function with a code: you can only clear the call costs by entering a four-digit code. No cost code is set ex-factory.

Switch box code - you can dial the switch box of your telecommunications system externally, e.g. switch the relays or perform room monitoring. You can protect the switch box against unauthorised access with the 4-digit switch box code. No switch box code is set ex-factory. You have to enter a switch box code if you want to use the switch box.

Service code - The service code authorises remote maintenance of your system. This means you do not have to enter your service technician's phone number if he moves, he only has to know the service code of your system and can maintain your system remotely from any location if you have released remote maintenance.

Programming your System

enter Codes

System PIN

Set 9*1: Initiates Programming
If the System PIN is required after pressing „9” enter 4 Digit PIN.
Switch on: „2”
Switch off: „1”,
„enter”, the actual code is shown in the display. Press „Clear” to delete it
Enter new 4 digit PIN
Confirm with „enter”
End Programming

Charge PIN

Set 9*2: Initiates Programming
the actual code is shown in the display.
Enter new 4 digit PIN
or Press „Clear” to delete it
Confirm with „enter” and End Programming

Switchbox PIN

Set 9*3: Initiates Programming
the actual code is shown in the display.
Enter new 4 digit PIN
or Press „Clear” to delete it
Confirm with „enter” and End Programming

Service PIN

Set 9*4: Initiates Programming
the actual code is shown in the display.
Enter new 4 digit PIN
or Press „Clear” to delete it
Confirm with „enter” and End Programming

Alarm PIN

Set 9*5: Initiates Programming
the actual code is shown in the display.
Enter new 4 digit PIN
or Press „Clear” to delete it
Confirm with „enter” and End Programming

ST 25

ST 30

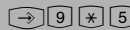
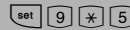
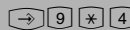
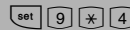
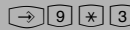
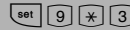
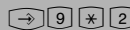
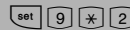
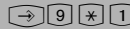
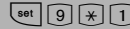

Programming your System

Enter System PIN

Programming mode must be started by entering:

*705

Lift receiver,





*7261,

enter 4 digit System PIN

Acknowledgement tone, replace receiver

Continue programming or end programming

mode by entering: *700!

 *7261   

Delete System PIN

Programming mode must be started by entering:

*705

Lift receiver, *7260,

delete System PIN

Acknowledgement tone, replace receiver

Continue programming or end programming

mode by entering: *700!

Enter System PIN?

If you hear the acknowledgment tone after

entering *705 no system pin is

programmed. You don't have to enter one.

If you don't hear the acknowledgment tone after

entering *705 a system code is





programmed. Enter the 4-digit System Pin. If the

code entered is right, you hear the

acknowledgment tone. If the PIN you entered is

wrong, you hear an error tone. Replace receiver

and start programming again.

 *7260   

Enter Charge PIN

Programming mode must be started by entering:

*705





Lift receiver, *7281,

enter 4 digit Charge PIN

Acknowledgement tone, replace receiver

Continue programming or end programming

mode by entering: *700!

 *7281   

Programming your System

Delete Charge PIN

Programming mode must be started by

entering: *705

Lift receiver, *7280,



delete Charge PIN

Acknowledgement tone, replace receiver

Continue programming or end

programming mode by entering:

*700!

 * 7 2 8 0  

Enter Switchbox PIN

Programming mode must be started by

entering: *705

Lift receiver, *7251,



enter 4 digit Switchbox PIN

Acknowledgement tone, replace receiver

Continue programming or end

programming mode by entering:

*700!

 * 7 2 5 1  

Delete Switchbox PIN

Programming mode must be started by

entering: *705

Lift receiver, *7250,



delete Switchbox PIN

Acknowledgement tone, replace receiver

Continue programming or end

programming mode by entering:

*700!

 * 7 2 5 0  

Programming your System

Maintenance/Testing

These functions must only be executed by a service technician.

- Display of the system type and of the software version number
- Setting the countrycode
- Service number define
- System restart (all user data is loaded anew into the RAM).
In this way, in certain circumstances an error can be remedied. All data stored by the user is left unchanged!)
- Clearing the memory (**caution: all data is cleared**. Each system has the "as-delivered" settings.)

A system restart and clearing of the memories result in waiting times of around 2 minutes. The display also goes off briefly and programming is ended.

Programming your System

Running the Maintenance and Testing Programm

ST 25

ST 30

Software Version and System Type

Set 9#1: Initiates Programming.

Pay attention to the display: You must enter the 4-digit setup code if it is prompted after you enter the number 9. The software version and the system type are displayed.

End Programming

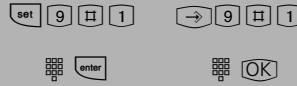

Service Number

Set 9#1: Initiates Programming.

Service number, which is able to remote control, configure or download new software after your permission (set *). If is Service number is already defined delete or change it

Enter Service Number

"enter":Confirm Input

End Programming

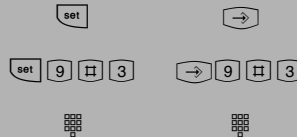

System Reset

Set 9#1: Initiates Programming.

enter":Confrim System Reset
All data is reloaded into Systems RAM,
Programming ends automatically
or

End Programming

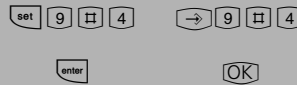

Erase RAM

Set 9#1: Initiates Programming.

"enter": confirm System reset
You have to confirm again with „enter“
(All Data will be erased, the System will be
resetted to delivery settings. This will take
approx. 2 Minutes))

or

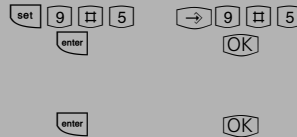

End Programming



Programming your System

Reset the System

Programming mode must be started by entering:

*705

Lift receiver

Reset System

Acknowledgement tone, replace receiver

End Programming mode by entering: *700

The System will reset

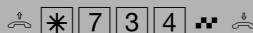

Erase the Systems RAM

Programming mode must be started by entering:

*705

Lift receiver

Erase RAM

Acknowledgement tone, replace receiver

The System will reset to delivery Settings

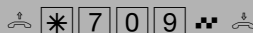

System phone registration

You can run 2 System Phone on every internal S0 of an AGFEO ISDN System. During configuration of the System every phone is registered with a primary and perhaps a secondary extension number.

When you plug a system phone into the system you have to register it.

If you plug a registered system phone of and plug it in on the same S0 after a while, you don't need to register it again.

If you plug it into another S0, you have to register it again.

The extension number can be changed at any time.

Systemtelephone deregistration

If you plug a system phone of for use on another S0, you should deregstrate it. Otherwise the extension number can not be used anymore.

Deregistrate system phones with the following procedure: *962

Programming your System

Changing extension number of a system phone

set9#6: Start programming

choose extension number with next

press enter to registrate the system phone with the highlited number.

ST 25

ST 30



Remote setting - Remote configuration

By means of "remote setting - remote configuration", your specialist dealer can program your telephone system according to your wishes, without having to travel to your house, and simply through your S0 basic access. In doing so, data protection is always guaranteed.

To allow remote maintenance, you should enter into the telephone system the "remote service number" your dealer uses or the "service number" your service center uses to maintenance. Remote service is only possible if the entered number agrees with the communicated phone number.

You also decide when and what is allowed to be programmed. For example, you decide whether the phone numbers in the phonebook can be read and written.

If you have allowed remote service, your specialist dealer can read out, modify and write back your telephone system's programming. Remote service remains allowed for 8 hours, after which it is again automatically disabled. For remote service, you may have to end your programming.

Programming your System

Remote Setting - Remote configuration

set *:Initiates Programming

enter Remote Configuration Number

Confirm with enter. You can decide if the setting is allowed without or

"next", with configuration of the phonebook.

end programming with set, remote configuration is allowed for eight hours.

ST 25

ST 30



enter Remote Configuration Number

lift receiver

remote configuration number

enter remote configuration number

replace receiver



Allow Remote configuration

lift receiver

allow remote configuration

0 = deny

1 = without phonebook

2 = with phonebook

acknowledgement tone

replace receiver



Downloading new software



AGFEO ISDN Telephone Systems can be upgraded to the latest firmware without the need of hardware changes. Your dealer can load the new firmware into the system with the use of a PC connected to the serial or USB port. Telephone systems with a SO connection may also be upgraded using a PC with an ISDN card connected to the internal SO bus. In addition your dealer may also upgrade your system remotely via an ISDN line. Please note that a remote configuration or remote firmware upgrade will not be possible via an analogue exchange line connection.

Programming your System

Advanced Users Programming



ST 25

ST 30

You can reach each program directly by pressing  and by entering the program number. You do not need to remember the program numbers. If you are experienced with programming trees, you can also navigate in the programming tree by pressing the  and  keys.

The programming tree is illustrated on the next pages.

Programming tree- rules for use

You initiate programming by pressing the  key. If necessary by pressing the  key several times, you can then reach the program point you are looking for.

Every program has a program number. With this number, you can move directly to every program point, e.g. "do not disturb" has the number 12 (1 from the first level and 2 from the second) and you can move directly to "do not disturb" by pressing "set 12".

Initiate programming



Scroll to the next program point



Scroll to the next program point



Move back by one program point



or

enter the required program number, e.g. 12, do not disturb



Move back by one level



Cancel programming: Press "esc" several times



or

end programming "set"



Programming your System

Programming tree



1 Function

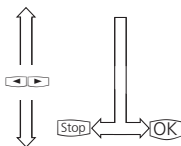

- 1 Call Variant 2/ Dorr Call Variant 2 (NightSERVICE on/off)
- 2 Do not Disturb (internal/external, on /off)
- 3 Telephone Lock (on/ off)
- 4 Call waiting (on/ off)
- 5 Appointment Call (Time/ Date and activate)
- 6 Wake Up Call (Time, on/ off)
- 7 Diversion to (to extension / externalno., on/ off)
- 8 Diversion from (from extension, on/ off)
- 9 Call forwarding (on / off)
- 0 Room Monitor (on/ off)
- *Automatic Dialling/ Hotline (on/ off)
- # Busy on Busy (on/ off)

2 System Phone settings

- 1 Ringing Volume (Set)
- 2 Ringing Tone or Pitch (Set)
- 3 Display Contrast 1 Contrast
- 2 Background Light (ST30 only)
- 4 Remote dialling 1 Remote Dialling (on/off/extension)
- 2 CTI-dialling (on/off)
- 3 Automatic Call (on/off)
- 4 Automatic Mike (on/off)
- 5 Accustik Settings 1 Speaker Volume
- 2 Receiver Volume
- 3 Headset Volume
- 4 Mike Volume Handsfree (ST 30)
- 5 Mike Volume Receiver (ST 30)
- 6 Mike Volume Headset (ST 30)
- (enter)
- 7 Telephone Lock (PIN) 1 external Status
- 2 internal Status
- 3 Pop Up Menu
- 4 Worldtime Clock (ST 30)
- 1 external
- 2 internal
- *Call Log 1 direct access
- 2 Call with receiver on hook
- # External Line access 1 direct access
- 2 Call with receiver on hook

3 Buttons / Names

- 1 Change Button assignment
- 2 Change extension Name

4 Destination Button

- Destination Button (Number / Name)

5 Phonebook

- 1 Phonebook store a number (Number / Name)
- 2 Phonebook change a number (Number / Name)
- 3 Phonebook delete a number (Number)
- 4 Enter Emergency Number (Number)
- 5 Enter Direct Call Number (Number)
- 6 Enter Automatic Dialling Number (Number)

Programming your System

Programming tree

6 TAM and SMS	Refer to Manual A Module 30
7 Charges	Own Charges
8 ISDN- Functions	1 ISDN call forwarding (always/on busy/ on no reply) 2 Clip (on/off) 3 COLP (on/off)
9 Configure System	1 Enter extension Numbers 2 Record AIS Announcements 2 Message Prior to Answering 4 Wake Up Alarm 5 Music On Hold * Codenumbers 1 System PIN 2 Charge PIN 3 Switchbox PIN 4 Service PIN 5 Alarm PIN # Maintenance/ Test 1 Firmware-Version 2 Country Code 3 enter Service Number 4 System Reset 5 Erase RAM Reset to delivery defaults) 6 ST 25 / ST 30 1 Version number 2 registration 3 deregistration 7 DECT 1 Handsets 1 registration 2 Specific Registration 3 deregistration 2 Basestations 1 Version 2 Update 3 Repeater 4 External Antenna 3 Headsets 1 registration 2 Specific Registration 3 deregistration 9 STE 30 1 Status 2 registration 3 deregistration 4 Version number

Programming your System

Programming tree

*** remote configuration** Remote configuration

Version Version (System Type / Firmware Version)

Programming your System

Communication via PC

Software Overview

The enclosed CD-ROM contains the following software: TK-Suite Basic, the TAPI-, USB and NDISWAN drivers for the AS 35, AS 35 All-In-One. To be friendly to our environment we have not included printed version of the individual programs as help will be available in each program by just clicking on the question mark.

System requirements

Following system features are required for the installation of the enclosed software

- IBM or compatible PC with hard disc and CD-ROM drive
- Pentium II with a processor speed of 233 MHz or higher
- 64 MB of available hard disc space
- Microsoft Windows 2000/ME/XP

Should you like to run TK-Suite with several clients then we would like to suggest to use Windows 2000 or XP as platform of your server installation.

TK-Suite Server

TK-Suite Server contains the following components, TK-Suite Set, TK-Suite Bill and TK-Suite contact. TK-Server is a program which runs in the background under Windows ME and as a service under Windows 2000/XP. This means that you do not work directly with the program but with the TK-Suite-Client and an Internet Browser application.

Communication via PC

TK-Suite Set



You can program the telephone system from your PC with **TK-Suite Set**. Call forwarding, ringing rhythms, day/night service and all ISDN parameters can be set quick and easy. With **TK-Suite** set you can save the telephone system configuration on your hard disc. If required you can send this back up data back to the telephone system. [see Chapter "Programming of the Telephone System"]

With the **LCR** component of TK-Suite Set you will be able to reduce call cost of your telephone system, provided your LCR table is kept up do date, by using the most cost effective service provider. Should this line be busy, then the automatic fallback function of the system will automatically select the next alternative service provider. A individual routing table can be created at any time to ensure cost effective phone calls. Should you like to take advantage to use a provider on a "call by call" * selection, without being registered to this or having an account, then this is also no problem. Up to eight providers with their dialling codes can be selected in a weekend profile. In addition you can select up to eight tariff tables.

*Network dependent

TK-Suite Bill



TK-Suite Bill is for the analysis of your call data. If your service provider should forward call charge information, then the software will record all call charges. TK-Bill will sort and calculate per extension, date, telephone number or customer. In addition a sort of all calls per providers is also available. TK-Bill will not only record calls cause a charge, but also records incoming calls.

TK-Suite Contact



TK-Suite Contact is your personal telephone and address book with multi user functionality. It is possible to import the phone book data of the telephone system into TK-Suite Contact. It works closely together with TK-Suite Client to give you a fully functional CTI working environment.

TK-Suite Client



TK-Suite Client serves to integrate all TK-Suite components in your desktop so that it is possible to access each tool per mouse click. In addition TK-Suite Client offers you a fully functional CTI workplace with the ability to call telephone numbers from TK-Suite Contact, display incoming calls and reminders with the resubmission function.

Communication via PC

Install TK-Suite

Start the installation routine of TK-Suite.

After you selected the installation folder and start up group, you will be asked from the TK-Suite Basic installation routine if the application should be installed as Single Work Station, Server – or Client version.



Select **Standalone** if you would like to use the Telephone System with one PC only.

Select **Server** if you would like to use the Telephone System with more than one PC.

Select **Client** if you would like to use the Telephone System with more than one PC and have already installed the Server Version to which you have access.

Please ensure that the User Setting has already been prepared on the Server for the Client.

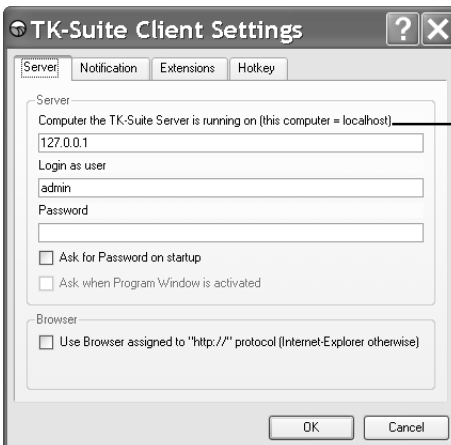

You will be asked for the Server Name, User Name and Password if you install TK-Suite Client to access TK-Suite Server on the network. Name and Password should have been allocated before in the TK-Suite Server version.

Communication via PC

Install TK-Suite

You select between an active an passive connection on installing TK-Suite Basic.

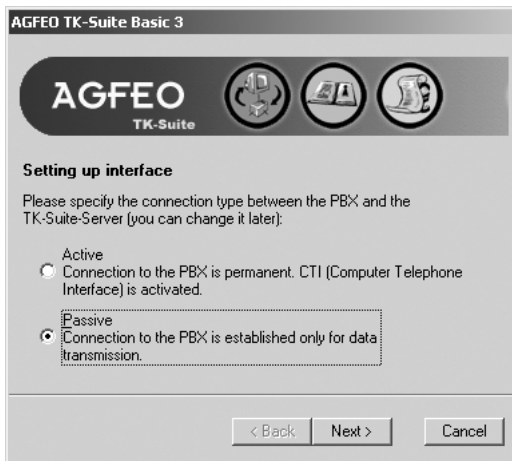

ACTIVE:

The connection to the Telephone System is permanent and the port to which the computer is connected is constantly in use and not available for any other application. A sensible choice for a Server or Single User if the CTI application should be used constantly.

PASSIVE:

The connection to the telephone system will only be established on programming or transfer of call charge data. The port may be used by other applications when not in use.

CTI is **not** possible with this setting.

Afterwards you may select the type of connection to the system:

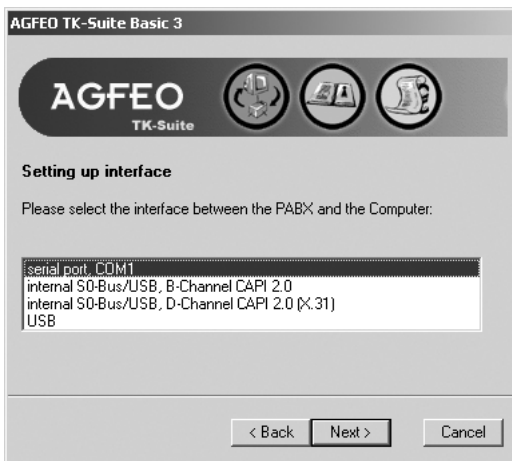

- Com1 or Com 2 if you want to communicate via the serial port with the system.
- Internal SO/USB Capi 2.0 if you want to communicate via the USB or ISDN connection. This type of connection does not support CTI and will not be offered if you have selected "Active" before hand.
- X31 if you want to communicate with the system via the internal SO or USB connection and not to engage a speech channel of the internal SO of the system.
- USB is for use with Com-Line products only.

To use CTI you must communicate with the system either via the serial port or via the X31 protocol.

Communication via PC

WAN Miniport

WAN Miniport is a driver for Windows 98 with which you can use the remote data transmission network via ISDN. Here you can connect to the Internet and interconnect computers (via the Remote Access service). You will find further information about the remote data transmission network in the Windows 98 documentation

CTI - computer-aided telephony via the TAPI interface

TAPI (Telephony Applications Programming Interface) is, unlike TK-Phone, not an autonomous CTI application but an interface between a TAPI-capable Windows application and the telecommunications system. If programs (applications) support this interface it is possible to control the telecommunications system. The scope of control depends on the application being used. However, it usually embraces the starting of outgoing calls (dial from the application) and display of incoming calls.

The TAPI is an interface of the Microsoft operating systems and the application side of the Microsoft Telephony interfaces. A Telephony Service Provider (TSP) from the manufacturer of the ISDN hardware - in this case AGFEO - is necessary to connect this interface. The TSP is a driver which you have to install on your PC. It performs the desired TAPI functions and controls the necessary data exchange between the PC and the telecommunications system. The TSP has to be updated continuously because of the constantly growing scope of functions of the TAPI supporting applications. To ensure you always have the latest TSP for your use we provide the TSP on our homepage in Internet under [http:// www.agfeo.de](http://www.agfeo.de).

The self-unpacking file contains all the information for installation and the supported applications. If you have no Internet access, contact your dealer or the info line fax: +49 521 4470998555

Making the USB connection

You can connect the telecommunications system with a desktop PC or notebook via the USB interfaces.

1. Take the USB cable provided. You will recognise it from the USB symbol on its plugs.
2. Plug the square plug (B plug) of the USB cable into the USB socket on the telecommunications system.
3. Plug the flat plug (A plug) of the USB cable into one of the USB connections on your computer.
4. Switch on your computer.

When you start Windows with the telecommunications system for the first time you will be prompted to state the position of the drivers. You can find out more about this in the „Driver software“ section.

Communication via PC

Installing drivers

Important Note! If you have already installed an ISDN card of another manufacturer in your computer you have to remove this and the drivers first. Follow the instructions in the manual of the respective manufacturer.

During installation, you may be prompted to insert the operating system CD. Keep your operating system CD close by. Before you install the driver software, the telecommunications system must be connected to the PC via the USB interface.

1. When the PC has recognised the connected telecommunications system, the hardware wizard appears. The hardware wizard installs the software for a new hardware component (AS 35/ AS 35 All-In-One). Click „Next“
2. In the following dialogue window select: „Search for the best driver for the device (recommended) and click Next
3. Activate the „CD-ROM drive“ option in the following dialogue and deactivate all other boxes. Insert the „Communication software“ CD with the USB drivers in the CD-ROM drive and click Next.
4. After the driver has been found, click Next to start installation.
5. The drivers are installed.
6. Read the information under „ISDN configuration“ and click „Next“.
7. Select the D-channel protocol: „DSS1: Euro-ISDN“ and click „Next“.
8. Now you are prompted to enter the phone number(s). Enter the internal number(s) at the USB access. All internal phone numbers are available (see system programming under port assignment). Click Next.
9. The ISDN configuration is terminated. Click „Finish“.
10. Insert the operating system CD when prompted to load the USB support. After the software for the new device has been installed, click „Finish“.
11. Restart your PC to complete installation.

If you want to change the phone number(s) for the PC at the USB access later:

Select „ Start → Programs → Accessories → Communication → Wizard for ISDN configuration“.

1. Read the information under „ISDN configuration“ and click „Next“.
2. Select the D-channel protocol: „DSS1: Euro-ISDN“ and click „Next“.
3. Now you are prompted to enter the phone number(s). Enter the internal number(s) at the USB access. Internal phone numbers 20 to 29 are available (see system programming under port assignment). Click „Next“.
4. The ISDN configuration is terminated. Click „Finish“.
5. Restart your PC to complete installation.

Communication via PC

Uninstalling drivers

If you do not want to use the driver software on your PC any longer you can uninstall it. Remove the AS 35 / AS 35 All-In-One in the system manager (you will find this under Windows/System Manager/Software/Uninstal/AGFEO).

Connection to the Internet or another network

Here you will find instructions how you can make a connection with the Internet or another network with the Microsoft remote data transmission network.

1. Open (double click) the icon „Work station“ on your desktop.
2. Open (double click) the icon „Remote data transmission network“
The remote data transmission network is automatically installed in the Windows 98 standard installation. If the „Remote data transmission network“ does not appear under „Work station“, you can install it now. Select „Start → Settings → System Manager → Software“. You will find further information in the index of the Windows help under the keyword „Software, installing components“.
3. If this is the first connection, click Next. Otherwise open (double click) „Create new connection“
4. Enter a name for the connection in the wizard, e.g. the name of your provider.
5. Under „Select a device“, select the „AGFWMP-Line 1“ and click „Next“
6. Enter the ISDN access number of your Internet provider or the remote network in the „Number“ box and click „Next“.
7. Click „Finish“. An icon is created for this connection

Configuring the connection

1. If the remote data transmission network is not open: Open (double click) the icon „Work station“ on your desktop. Open (double click) the „Remote data transmission network“ icon.
2. Open the dialogue window in which you can configure your connection. Click the right mouse button on the icon of the previously set connection and select „Properties“.
3. Activate the „Server type“ tab. Perform the following steps:
 - When you set up a connection to the Internet, deactivate Log in to network.
 - Activate „Software compression“.
 - For connections to the Internet, only activate „TCP/IP“ as a protocol.

Communication via PC

Dialling into the Internet or another network

After you have set up the connection to your Internet provider or the network as described you can now dial into the appropriate network.

If you want to surf in the Internet or call your e-mail, you have to have installed a web browser or an e-mail application.

Perform the following steps to connect:

1. Open (double click) the icon „Work station“ on your desktop.
2. Open (double click) the „Remote data transmission network“ icon
3. Open (double click) the icon of the previously set connection.
4. Do the following in the „Connect with“ dialogue window:
Enter the user name and password given by your network provider. Click „Connect“
The dialogue window „Connected with“ appears as soon as the connection is established.
5. You can now surf in the Internet with the web browser or call your e-mails with an e-mail application.

Disconnecting

Click „Disconnect“ in the „Connected with“ dialogue window to cut off the connection. If this dialogue window has been minimised to an icon you have to click the icon in the task bar.

Glossary

Answering station - VST

The answering station controls your ISDN connection. You can use some functions such as the ISDN call forwarding or the ISDN-hold via the answering station with the ISDN features.

Appointment - wake-up

The system telephones remind you of a fixed appointment (date/time) with the appointment call and flashing LED. With a wake-up call the system telephones wake you every day at a fixed time.

Automatic dialling

When this feature is activated, your telephone system automatically calls the previously entered number when you lift the handset and do not press any other key for 10 seconds. The number is dialled up to 12 times at one minute intervals until a connection is made.

Busy On Busy

This feature of the telecommunications system causes the whole line to be busy when a subscriber is holding a conversation from a call variant/call distribution. Unlike camp on protection, this function works for a complete phone number (MSN) not just for one subscriber.

Call by call

With the call by call feature you can select a desired network provider for a long distance call. You have to set up a call by call function key.

Call diversion - diversion to

All incoming calls can be diverted to a specific external or internal destination telephone. Unlike call forwarding (ISDN) in which there is no connection to your ISDN telecommunications system, the call diversion to the external subscriber uses a second B-channel to reach the desired destination. This may even save money because the Least Cost Router can be used to make the connection. Two B-channels are occupied during the all diversion.

Glossary

Call forwarding - ISDN call forwarding

With this ISDN service feature, calls for your ISDN connection can be forwarded worldwide to any other connection. You enter the destination number in your ISDN telecommunications system and activate the call forwarding in your public exchange. The exchange then re-routes all calls without the telecommunications system noticing (see call diversion). With call forwarding on the system connection you always forward the whole connection. On a multipoint connection you can divert every phone number (MSN) individually to a respective different destination. Call forwarding is possible in the variations permanent, when no answer and when busy. The call forwarding feature can only be used by special agreement with your network provider.

Call list

The call list stores external calls with transmitted phone number with phone number and date/time if the call cannot be answered. On the system telephones and many ISDN telephones the call list can be called at any time and the subscriber called directly by pushing a key. Any phone number can be dialled by a mouseclick from the call list of TK-Phone (part of TK-Soft).

Call variant

The internal phone numbers of the terminal that are rung in the event of an external call are defined in a call variant. Different call variants can be defined for the day or the night service. Call variant 1 (day time service) and call variant 2 (night service) can be switched over at any time from any telephone.

Camp on protection - reject camp on

Camp on tones during a telephone call signal that another subscriber is calling. The first caller can be held in the line while you ask the second caller what he wants. This means no calls are missed. Anyone who considers this as a disturbance can switch it off with the camp on protection. The second caller either gets the busy tone or lands on an answering machine for example.

Charging shell switch

With the charging shell switch it is possible to switch functions in the telecommunications system by inserting and removing the DECT 30 in and from the charging shell. The switching can be done for any subscribers. For example the answering machine can be switched on or the call variant changed by removing the DECT 30. The functions for the charging shell switch are set up with the PC using TK-Soft (DECT options).

Glossary

Code numbers

Every connected telephone can be protected against unauthorised access by a 4-digit code (telephone lock) so that with the exception of direct numbers, emergency numbers and automatic dialling only internal numbers can be dialled. No code numbers are entered ex-factory.

Connection data records - call data records

Your ISDN telecommunications system sets up a connection data record for every external call. This tells you that an internal subscriber has made an external call at a certain time on a certain day under a certain MSN for a certain time. This may have caused a number of units and the associated costs, the latter providing call costs are transmitted. Under Registered connections in the configuration program TK-Set you have the possibility of registering either outgoing, none, incoming or all connections. If the connection data records are not printed directly via the serial interface on a printer 100 to 2000 entries are saved depending on the system type which can then be evaluated by TK-Bill (part of TK-SET).

Pop Up menu

The context menu offers you functions which appear useful at the time, e.g. you will be offered the refer-back and disconnect functions when telephoning. It simplifies operation, you do not have to set up a function key for every function which appears reasonable.

Charge code

In principle, every subscriber of your ISDN telecommunications system can clear his call costs. You can also lock out this possibility by entering a four-digit code. No cost code is set ex-factory.

Dialling line (B-channel/S0 basic access)

You can connect an external S0 basic access to your ISDN telecommunications system. Every external S0 basic connection behaves like two conventional analogue dialling lines. You therefore have two dialling lines (B-channels) on which you can make external calls (local, long distance or international).

Glossary

Dialling preparation

The dialling preparation enables you to first enter a number and then activate dialling by lifting the handset. This also applies for phone book and redialling.

Direct call - baby call

The direct call only works when the telephone is locked. Regardless which key is pressed, only the previously programmed phone number is dialled.

Divert from

You can divert all calls of other telephones individually to your telephone. You can telephone as normal from the diverted telephone. On lifting the handset a special dialling tone reminds you that the diversion is activated.

Do not disturb

Calls are no longer signalled acoustically when this feature is activated in the telephone. You can select whether only the internal calls, only the external calls or all calls are not to be signalled. However, internal calls are still signalled optically on the system-internal system phone.

Door handsfree device (TFE)

Door intercom with bellpush and door opener which can be connected to your telecommunications system. You can talk to a visitor at the door and open the door from your telephone.

DTMF post-dialling

For all existing external connections, including refer-backs, brokering and during a three-party conference, it is possible to post dial digits and characters (1 ... 0 , * and #). With the „Remote scan“ key stored DTMF tone sequences can be post-dialled, e.g. for remote scanning of an answering machine.

Dual tone multifrequency dialling (DTMF)

Every dialled digit is assigned a specific tone. Telephones that operate on the basis of this dialling method require a signal key (inquiry key R)/flash function on the telephone system.

Glossary

Emergency call numbers

The emergency call numbers can only be dialled with the system telephone lock activated. When the handset is on the hook you only need to press the Alt key plus asterisk * (emergency call 1) or # (emergency call 2) and confirm with OK to start dialling.

External dialling

External dialling means that you can make a call for another subscriber. For example the secretary for the boss or the ST 30 for the DECT 30.

Identifying malicious callers - tracing

The „Malicious call tracing“ feature can only be used by special agreement with your network provider. The ISDN exchange stores the number of the caller, your number, the date and the time of the call. You can have the caller identified during the call. You activate this procedure on the system telephone with the „Trace“ function key. A key combination is used for this on analogue telephones.

Intercom function - announcement - intercommunication

The connection of the system telephones (ST20/ST25/ST30) replaces an intercom system. When a system telephone is called, the microphone switches on automatically (if programmed) enabling you to talk and listen. If you have not switched on the automatic microphone you have to use the handset or the loudspeaker key for intercommunication. The microphone is not activated when an announcement is made to several telephones. Announcements to system telephones can also be made from normal telephones. Please refer to the operator manuals for analogue terminals - Announcement for a description of this procedure.

ISDN-hold

The ISDN-hold feature is only available at the multipoint connection. You can have your external call held by the ISDN exchange to hold a refer-back conversation with a second external subscriber on the same line. Then you can switch back to the first call. You can also switch between the two calls (broker) or start a conference in the exchange.

Least Cost Routing - LCR

You can reduce your call costs with the Least Cost Routing by using the respective cheapest network provider. With the TK-LCR software every subscriber can set up his individual table for cost-optimised telephoning or load existing tables in the system. Up to 8 providers must be entered individually by a profile. In addition, 8 areas, e.g. city, region 50, German, Euro I, mobile etc. can be freely defined.

Glossary

Module slot

Modular telecommunications systems have module slots.

Phone book

The telecommunications systems save external phone numbers and names in the phone book. System and value added telephones can use the alphanumerics of the phone book. Analogue telephones can dial the phone numbers with the speed dialling numbers. If a phone number is transmitted with an incoming call and this is in the phone book, the display of the system telephone displays the name instead of the number.

Phone numbers

An external phone number is the number transmitted to outgoing external connections. An internal phone number is the number of a subscriber under which he can be reached internally on your telecommunications system. A phone number is the number (MSN) assigned to you by your network provider.

Private destination

You store a private, individual phone number which is only stored on your telephone under a private destination key.

Public destination

You store a phone number from the telecommunication system's phone book which you want to call very often quickly under a public destination key.

Relays

The relays may have on/off or impulse functions depending on the programming. In addition they can be assigned internal numbers and control additional bells or beacons. The relays can also be controlled remotely.

Seizure

Seizure of an outside line (B channel) to call an external subscriber.

Setup code

Normally every subscriber can make settings on your system. You can lock all system-relevant functions so that these functions can only be used after entering a four-digit setup code. You can switch the setup code on and off or change it. The code is set ex-factory to 2580.

Glossary

Speed dialling - destinations in the phone book - according to numbers

Phone numbers of certain external subscribers are stored in the speed dialling memories. Every memory slot has a speed dialling number under which the external phone number is stored. The system converts the speed dialling number into the full number when it is called. All extensions can dial phone numbers from the central speed dialling memory.

Status display - busy display

The system telephone display indicates how many lines are free and whether special functions (call variants, call list and others, call diversions) are activated. A busy display of the internal subscribers is also possible.

Telephone lock

You can protect your telephone against unauthorised use by locking it. If your telephone is locked you can only call internal subscribers, answer all incoming calls and switch internally, dial the stored direct numbers externally, dial the stored emergency numbers externally and perform external automatic dialling. If you have programmed a telephone code for your telephone you have to enter your 4-digit code to unlock it.

Timer

The telephone system has timers that can be used to activate certain functions at specific times. The following features can be time controlled:

- AIS announcement text
- Busy-on-busy
- Call barring
- Call Distribution by Day / Night
- Call Distribution Door
- Call Distribution Forwarding
- Diversion
- Do not disturb
- Hunt group mode
- Phone lock
- Phonebook Macro
- TAM

You can assign one or more functions to any timer. Up to 10 functions can be switched by timers. The timers can only be programmed in the "TK-Suite" program.

Transfer

With the Transfer function you have the option of transferring an external call to an external subscriber. Two dialling lines (two B-channels) are occupied.

Your subscriber connection is charged for the external connection you set up. You can set up the Transfer function key on the system telephone, on the analogue telephone you use the code number procedure.

What to do in the event of malfunctions

Checks

- In the event of malfunctions on the telephone system, please check your operating actions by referring to the instruction manual.
- Check whether the connectors of terminals and of the telephone system are inserted correctly.
- If you cannot remedy a malfunction, your dealer will be please to help you.

Deactivating the special dial tone

When you lift the receiver on your standard telephone, you hear the special dial tone. You hear the special dial tone when do not disturb, automatic dialling or a diversion is active. You can deactivate all functions that result in a special dial tone by entering a code.



Lift handset

Deactivate special dial tone functions

Acknowledgement tone

Replace handset

Power Failure

- If the power should fail, you can make neither external nor internal telephone calls.

When the power returns:

- The telephone system functions again according to the previously set program. All settings made via the programming mode or the PC program remain stored provided the programming mode was ended appropriately.
- Initiated return calls are cleared.
- Connections parked in the telephone system are cleared.
- The redial entries are cleared.
- The total connection charges and the connection records are stored.

What to do in the event of malfunctions

What to do in the event of malfunctions

<u>Malfunction</u>	<u>Possible causes</u>	<u>Remedy</u>
Telephone system programming unclear		Reset the telephone system Reset the telephone system to the „as-delivered“ settings and reprogram it
No dial tone after lifting handset	Power failure Terminal defective Incorrect installation	Check mains connection/fuses Check terminal on another connection Check connections at the connection socket and on the telephone system
No internal calls arrive	Do not disturb (special dial tone) Diversion to another telephone (internal/external) (special dial tone)	Turn off do not disturb Turn off diversion to
No external calls arrive	Do not disturb (special dial tone) Diversion to another telephone (internal/external) (special dial tone) ISDN call forwarding is active Point-to-point connection: System phone number missing Point-to-multipoint connection: - MSN missing - MSN-internal user assignment missing	Turn off do not disturb Turn off diversion to Deactivate ISDN call forwarding Enter the system phone number Enter the MSN Assign the internal user to the MSN(ringing distribution)
Forwarding an external call (inquiry) is not possible	The inquiry key [R] on the telephone is set as an earth key Wrong flash time	Set the telephone to DTMF and set the inquiry key to flash Adjust flash time on the phone or on the respective port of the PBX.
Distorted speech connection	S0 bus incorrectly installed Connection error	Connect wire pairs correctly

What to do in the event of malfunctions

Resetting the telephone system

By resetting, you can restore the telephone system's programming to a defined state. This may be necessary if you wish to reset unclear settings or if you wish to reprogram the telephone system.

After a reset, the telephone system again operates according to the previously set program. All settings made in the programming mode or by means of the PC program are retained provided the programming mode has been ended properly.

Important: the following are cleared when you reset the telephone system. - All existing internal and external connections

- Remote support
- Internal return calls
- ISDN callback on busy
- Outside line reservations

Hardware reset - unplug the 230 V power mains plug and then plug it in again.

Software reset - carry out the following procedure:

Software reset via analog terminals / ISDN terminals

Programming mode must be started by entering:  →      



Lift handset

Reset the telephone system

Acknowledgement tone

Replace handset

The reset is performed.

Software reset via System telephones

Start the function.

Watch the display: If the setup code is requested after pressing the 9, you have to enter the 4-digit code.

„next“: Scroll to the „Clear memory“ menu

„enter“: Start clear memory (reset the ex-factory state of the system), a security prompt appears

„enter“: Confirm clear memory if you really want to continue.

The memories are cleared (approx. 2 minutes). (all data are cleared and the programming is ended automatically)



Appendix

Rings

All ringer rhythms for incoming calls begin with an initial 500 ms pulse, followed by a 2 second pause. This is a technical requirement to allow caller identification (Calling Line Identification Presentation - CLIP). Thereafter the ring can be programmed differently to distinguish between calls to different extension numbers in the system (see diagram)

Ring Rythms

External Call

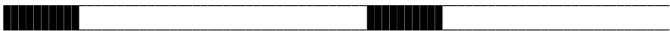
Standard Ring 

An external subscriber calls

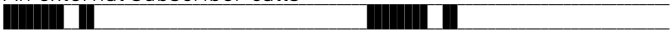
Code ring 1 

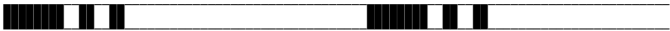
Code ring 2 

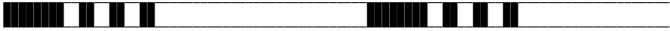
Code ring 3 

Code ring 4 

Internal Call 

An internal subscriber calls

Door ringing 

A visitor rings at the door

Code call rings to radio cells

- Code ring 1 

Call via the first internal phone number

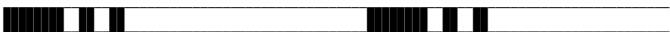
- Code ring 2 

Call via the second internal phone number

Outside line reservation / 

Appointment call (system telephone)

Wake up call (system telephone) 

1 minute rising volume

Key: 0-----1-----2-----3-----4-----5-----6-----7-----8-----9 s













Call break Call break Continued

Note

Ringing may differ depending on the terminal used. The code calls 3 and 4 are not signalled to analog ports that are set to type „radio cell“.

Appendix

Tones

Dial tone - internal		...
	Signals that you may dial after lifting handset	
- external		...
	Continuous tone that you hear when you have seized an outside line after dialling "9" or pressing an MSN key	
Ringing tone - internal		...
	Internal user is rung	
- external		...
	External user is rung	
Busy tone		...
	The dialled internal user or external subscriber is busy	
Special dial tone		...
	Signals that you may dial after lifting the receiver, but that do not disturb, autodial or diversion is on	
Call waiting - internal / door		...
	During a call, this tone signals an internal call or a door call	
- external		...
	During a call, this tone signals an external call	After 10 seconds
Acknowledgement tone		...
	Input accepted	
Error tone - a/b -Telephone		...
	Operating error/ input rejected	
- System-telephone		...
	Operating error/ input rejected	
Key:	0-----1-----2-----3-----4-----5-----6-----7-----8-----9 s	...
		...
	tone break tone break tone	continued

Index

Index

A

Accepting Incoming Calls 1 - 23, 2 - 7
Adjusting the flash time 4 - 6
Advanced Users Programmin 4 - 17
Alphabetic 1 - 66
Announcement 1 - 39
Announcement Button 1 - 16
Answering station - VST A - 2
Appointment Call 1 - 70
Auto Dialling 1 - 39
Auto Dialling (Hotline) 2 - 17
Automatic Call 1 - 45
Automatic Call Back 1 - 58, 2 - 29
Automatic Mike 1 - 45
Automatic Redial 1 - 86

B

Baby call 2 - 33
Baby Listening 1 - 55
Baby Listening / Room Monitor 2 - 25
BROKERS CALL 1 - 26
Busy on Busy 1 - 40, 2 - 18
Button Assignment 1 - 14
Button Assignment of Specific Functions 1 - 15

C

Call by Call 1 - 12, 1 - 53
Call Deflection 1 - 38
Call Forwarding 1 - 15, 1 - 80, 2 - 43
Call Forwarding (on/off) 1 - 36
Call Log 1 - 10, 1 - 31
Call Log ON / OFF 1 - 10
Call Log on/off 1 - 31
Call on Hold 1 - 44
Call Pick Up 1 - 16, 1 - 30, 2 - 12
Call Split 1 - 51
Call Transfer 1 - 25, 2 - 8
Call Transfer without announcement .. 1 - 26
Call Waiting 1 - 23, 2 - 12
Call waiting 2 - 7
Call waiting / Call Back 2 - 10
Call Waiting / Callback when free 1 - 27
Call Waiting on/off 1 - 29
Callback 1 - 28
Calling an external number 1 - 20
Callthrough 2 - 49
Cancelling room monitoring 2 - 26
Carrier Access Code 1 - 53
Changing a Number in the Phonebook 1 - 62
Check contents of delivery 1 - 3
Check in / Check out 1 - 83
Cleaning 1 - 5
Conference 1 - 47, 2 - 22
Connecting a PC 4 - 3
contents of delivery 1 - 3

Cost display 1 - 8
CTI - computer telephony integratio E - 10
CTI - computer telephony integration .. E - 10
CTI Dialling 1 - 45

D

Day and Night Service 1 - 34
Deactivating the special dial tone A - 9
Deleting a Number from the phonebook 1 - 63
Dialling Numbers from the Phone Book 1 - 64
Direct call 2 - 33
Direct Call (Baby Call) 1 - 68
Display and delete call charges 1 - 82
Display Call Charges on an analogue phone - 46 2
Diversion from 1 - 77, 2 - 40
Diversion to 1 - 78, 2 - 41
Do Not Disturb 1 - 33, 2 - 13
Do not disturb 1 - 15
Door Call Variant 1 - 73
Door opener 1 - 75
Door Phone and Lock Release 1 - 18
Doorphone 1 - 75
Doorphone Diversion 1 - 74, 2 - 35
Doorphone Night Service 2 - 37
Downloading new software 4 - 16

E

Emergency Call 1 - 69
Enquiry 1 - 57, 2 - 28
enter Codes 4 - 9
Entering an Emergency Number 1 - 63
Extended redial 1 - 86
Extension Status 1 - 59
External Acces with specific MSN 2 - 5
External Access with MSN Button 1 - 21
External Access with special MSN Button 1 - 21
External Line Access 1 - 11, 2 - 3
External S0-Connection Fixed S0-0(RJ45 Socket) 1 - 9
External Transfer 1 - 26, 2 - 9

G

Group Button 1 - 16
Groups 1 - 91, 2 - 48

H

Handsfree Microphone - Set to Auto on 1 - 7
Headset 1 - 12

I

Important notes on using analogue equipment E - 8
Important notes on using ISDN terminals E - 9
Insertion of label strips for function buttons 1 - 5

Index

Intercom (Specific Extension) 1 - 17
Internal Call Forwarding on / off 2 - 16
Internal S0-Connection 1 - 11
Internal Transfer 2 - 9
Internal Transfer with announcement 1 - 25
Interner S0-Anschluß 1 - 10

L

Least Cost Routing 1 - 50
Least Cost Routing (LCR) 2 - 24
Log In / Log Out 2 - 48

M

Mains Socket 1 - 3
Maintenance/ Testing 4 - 12
Make a Call Spontaneous seizure with internal 1
- 20
Making a Call 1 - 19, 2 - 3, 2
- 4
Malicious Call Identification (MCID) 1 - 46, 2 - 22
Montage. *Siehe* Installation
MSN CO Button 1 - 17
Music on Hold (MoH) 3 - 4

N

Night Service 1 - 15
Night Service on/off 1 - 34
Notes on programming with S- procedures 4 - 5
Numeric retrieval 2 - 30

O

Open Connection Cover 1 - 5
Operating the Doorphone and Door opener 2 - 38
Overview of freely programmable Function Buttons 1
- 12

P

Parking a Call 1 - 54, 2 - 24
Phonebook 1 - 61
Pictograms and Buttons E - 11
Piktogramme E - 11
Pop Up Menu 1 - 60
Power Failure A - 9
Printing of Metered Call Charges 1 - 82
Programming from the system telephone 4 - 4
Programming tree 4 - 17
Programming via PC 4 - 3

R

Reject a call 1 - 38
Relay 1 - 18
Remote Answering 1 - 16
Remote Dial Functions 1 - 45, 2 - 21
Remote setting - Remote configuration 4 - 15
Request Ringback 2 - 10

Requesting Ring back when free 1 - 27
Reserving an Outside Line 1 - 21
Reserving an outside line 2 - 5
Reset the System 4 - 14
ringer rhythm 4 - 7
Rings A - 12
Room Monitor 1 - 55

S

Safety Notes 1 - 5
Scrolling through Display Messages ... 1 - 59
Sending CLIP or COLP 1 - 76, 2 - 39
Set Date & Time 1 - 9
Setting External Seizure 2 - 3
Setting the Display Contrast 1 - 7
Setting the Headset Volume 1 - 7
Setting the Ringers Tone or Pitch 1 - 6
Setting the Ringing volume 1 - 6
Setting the Speaker Volume 1 - 7
Setting up and cleaning the system telephones 1
- 5
Single Button Dialling 1 - 89
Software reset A - 11
Softwareübersicht PC - 3
Spontaneous Outside Line Seizure 2 - 5
Starting the programming mode 4 - 5
Status Display & Date/ Time 1 - 9
Storing a Number 1 - 61
Storing and Dialling Phonebook Numbers 2 - 30
Storing the Last Number 1 - 52
Switchable S0 Connection S0 1(internal or external
1 - 10
Switching between Day and Night Service 2 - 14
Switching over the door call variant 2 - 36
Switching Relays 1 - 56, 2 - 27
System phone registration 4 - 14
System Redial 1 - 86
System requirements 4 - 3
System Telephone ST 25 1 - 3
System Telephone ST 30 1 - 4
System telephones E - 11
System Telephones - settings 1 - 6

T

TAPI E - 10
Telephone Answering Machine (TAM) .. 1 - 91, 2 - 47
Telephone Lock 1 - 68
Telephone lock 2 - 32
Telephone Lock (PIN) 1 - 8
Timer 1 - 72
Timer Functions 2 - 34
TK-Suite Set PC - 4
TK-Suite Bill PC - 4
TK-Suite Client PC - 4
TK-Suite Contact PC - 4
To place a Call on Hold 2 - 20
To Set Date & Time 1 - 9
Tones A - 13

Index

Tracing a Call 1 - 46, 2 - 22
Transfer an Outside Line 1 - 27

U

USB-Verbindung herstellen PC - 7

V

Vanity 1 - 66, 2 - 30
Voice Message 1 - 41
Voice MessageAnnouncement 2 - 19

W

Wake Up Call 1 - 87, 2 - 50
Wall Mounting 1 - 4
WAN Miniport-Treiber PC - 7
What to do in the event of malfunctions A - 10
World Clock 1 - 88

Index

Copyright

Copyright 2002 **AGFEO** GmbH & Co. KG
Gaswerkstr. 8
D-33647 Bielefeld

We reserve all rights to this documentation, this applies especially in the event of a patent award or registered utility.

The documentation may not be changed or translated manually in any other way into any language or computer language of any form by any means neither wholly nor in part without our express permission. This applies for electronic, mechanical, optical, chemical and all other media.

Trade marks and names used in this documentation are subject to the rights of the companies concerned.

Technical Modifications

The AGFEO GmbH & Co. KG reserves the right to change representations and data in this documentation in the interests of technical progress without prior notice.

This documentation has been prepared with the utmost care and is revised regularly. Despite all care, however, technical inaccuracies and typographical errors cannot be totally ruled out. All errors which become known to us will be corrected in new editions. We are gratefully for any hints at errors in this documentation.

You can only use the numerous ISDN features of your AGFEO ISDN telecommunications system if your network operator provides them.

EU-Konformitätserklärung

EC-Declaration of Conformity
CE-Déclaration de Conformité

Der Hersteller: AGFEO GmbH & Co. KG

The Manufacturer:
Le Constructeur:

Adresse: Gaswerkstr. 8
D - 33647 Bielefeld

Address:
Adresse:

Erklärt, dass das Produkt: AS 35

Declares that the Product:
Déclare que le Produit:

Type: Telefonanlage

Model: AS 35

Components:

die grundlegenden Anforderungen gemäß Artikel 3 der nachstehenden EU-Richtlinien erfüllt:

meets the essential requirements according to article 3 of the following EC-Directive:
est conforme aux exigences essentielles d' article 3 de la Directive CE:

**Richtlinie 1999/5/EG des Europäischen Parlaments und des Rates vom 09. März 1999
über Funkanlagen und Telekommunikationsendeinrichtungen und die gegenseitige
Anerkennung ihrer Konformität**

Directive 1999/5/EC of the European Parliament and of the Council of 09 March 1999 relating to radio and
telecommunications terminal equipment, including the mutual recognition of their conformity
Directive 1999/5/CE du Parlement européen et du Conseil du 09 mars, 1999 concernant les radio et équipement terminaux de
télécommunications, incluant la reconnaissance mutuelle de leur conformité

und dass die folgenden harmonisierten Normen angewandt wurden:

and that the following harmonised standards has been applied:
et que les standards harmonisés suivants ont été appliqués:

EN 55022/2003
EN 55024/2003

Bielefeld, 21. April 2005

Ort und Datum der Konformitätserklärung
Place and date of the declaration Lieu et date de la déclaration

Phone : +49(0)5 21 44 70 9-0
FAX : +49(0)5 21 44 70 9-50

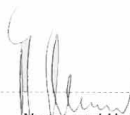

Name und Unterschrift
Name and Signature Nom et Signature

Declaration of Conformity

EU-Konformitätserklärung

EC-Declaration of Conformity
CE-Déclaration de Conformité

Der Hersteller: AGFEO GmbH & Co. KG

The Manufacturer:
Le Constructeur:

Adresse: Gaswerkstr. 8
D - 33647 Bielefeld

Address:
Adresse:

Erklärt, dass das Produkt: AS 35 All-In-One

Declares that the Product:
Déclare que le Produit:

Type: Telefonanlage

Model: AS 35 All-In-One

Components:

die grundlegenden Anforderungen gemäß Artikel 3 der nachstehenden EU-Richtlinien erfüllt:

meets the essential requirements according to article 3 of the following EC-Directive:
est conforme aux exigences essentielles d' article 3 de la Directive CE:

Richtlinie 1999/5/EG des Europäischen Parlaments und des Rates vom 09. März 1999 über Funkanlagen und Telekommunikationsendeinrichtungen und die gegenseitige Anerkennung ihrer Konformität

Directive 1999/5/EC of the European Parliament and of the Council of 09 March 1999 relating to radio and
telecommunications terminal equipment, including the mutual recognition of their conformity
Directive 1999/5/CE du Parlement européen et du Conseil du 09 mars 1999 concernant les radio et équipement terminaux de
télécommunications, incluant la reconnaissance mutuelle de leur conformité

und dass die folgenden harmonisierten Normen angewandt wurden:

and that the following harmonised standards has been applied:
et que les standards harmonisés suivants ont été appliqués:

EN 55022/2003
EN 55024/2003

Bielefeld, 6. Juni 2005

Ort und Datum der Konformitätserklärung
Place and date of the declaration Lieu et date de la déclaration

Phone : +49(0)5 21 44 70 9-0
FAX : +49(0)5 21 44 70 9-50

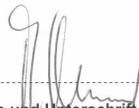

Name und Unterschrift
Name and Signature Nom et Signature



The crossed out wheeled bin on the product means that this belongs to the group of Electro- and electronic apparatus.

In this context you are directed by the European regulation to dispose of used apparatus

- at the point of buying an item of equal proportion / value
- at the local available collection point for disposal

With this you will participate in the reuse of material and valorisation of disused electric- and electronic apparatus, which otherwise could be a health hazard and be negative to the environment.

Ident no. 1100930

Subject to change without notice.

No liability can be accepted for errors contained in this document.

Printed in Germany
0059

AGFEO GmbH & Co. KG

Gaswerkstr. 8

D-33647 Bielefeld

Internet: <http://www.agfeo.com>